

V_{RSM}	I_{FRMS} (maximum value for continuous operation)			
V_{RRM}	110 A		325 A	
	I_{FAV} (sin. 180; $T_{case} = 85\text{ °C}$; 50 Hz)			
V	48,5 A		207 A	
100	SKKD 50 E 01	SKND 50 E 01	SKMD 202 E 01	SKND 202 E 01
200	SKKD 50 F 02	SKND 50 E 02	SKMD 202 E 02	SKND 202 E 02
300	SKKD 50 E 03	SKND 50 E 03	SKMD 202 E 03	SKND 202 E 03
400	SKKD 50 E 04	SKND 50 E 04	–	–

Ultrafast Epitaxial Diode Modules

SEMIPACK® 1
SKKD 50 E SKND 50 E

SEMIPACK® 2
SKMD 202 E SKND 202 E

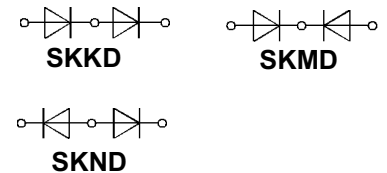
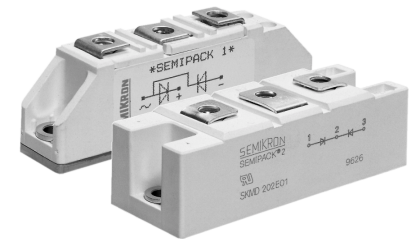

Symbol	Conditions	SKKD 50 E SKND 50 E	SKMD 202 E SKND 202 E	Units
I_{FAV}	sin. 180; $T_{case} = 85\text{ °C}$	48,5	207	A
I_{FSM}	$T_{vj} = 25\text{ °C}$ $T_{vj} = 150\text{ °C}$	800 700	3 200 2 800	A A
i^2t	$T_{vj} = 25\text{ °C}$ $T_{vj} = 150\text{ °C}$	3 200 2 450	51 000 39 000	A^2s A^2s
t_{rr}	$T_{vj} = 25\text{ °C}$; $I_F = 1\text{ A}$; – $di_F/dt = 15\text{ A}/\mu s$; $V_R = 30\text{ V}$, $I_{rr} = 0,25 I_{RM}$	60	140	ns
Q_{rr}	$T_{vj} = 150\text{ °C}$; $I_F = 50\text{ A}$; – $di_F/dt = 100\text{ A}/\mu s$; $V_R = 100\text{ V}$	0,7 10	2 16	μC A
I_{RM}				
I_R	$T_{vj} = 25\text{ °C}$; $V_R = V_{RRM}$	0,2	2	mA
I_R	$T_{vj} = 130\text{ °C}$; $V_R = V_{RRM}$	40	100	mA
V_F	$T_{vj} = 25\text{ °C}$; ($I_F = \dots$); max.	1,6 (120 A)	1,65 (500 A)	V
$V_{(TO)}$	$T_{vj} = 150\text{ °C}$	0,8	0,8	V
r_T	$T_{vj} = 150\text{ °C}$	6,5	1,5	$m\Omega$
R_{thjc}	per diode / per module	0,85 / 0,43	0,2 / 0,1	$^{\circ}C/W$
R_{thch}	per diode / per module	0,2 / 0,1	0,1 / 0,05	$^{\circ}C/W$
T_{vj}		– 40 ... + 150		$^{\circ}C$
T_{stg}		– 40 ... + 125		$^{\circ}C$
V_{isol}	a. c. 50 Hz; r.m.s.; 1 s/1 min	3000 / 2500		V~
M_1	to heatsink } SI (US) units to terminals }	5 (44 lb. in.) $\pm 15\%$		Nm
M_2		3 (26 lb. in.) $\pm 15\%$		Nm
w	approx.	120	250	g
Case		SKKD SKMD SKND	A 20 A – A 51 A 19	– A 51 A 52

Features

- Isolated metal baseplate
- Very short recovery times
- Low switching losses
- Up to 400 V peak inverse voltage
- **SKKD** half bridge or centre tap connections:
SKMD common cathode
SKND common anode
- UL recognized, file no. E 63 532

Typical Applications

- Switched mode power converters
- Invers diode for transistors in AC and DC motor controls
- Uninterruptible power supplies (UPS)

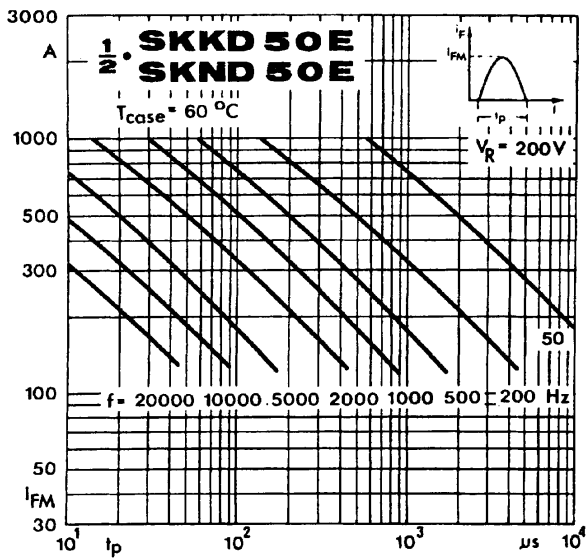

Fig. 12 a Rated sinusoidal peak forward current

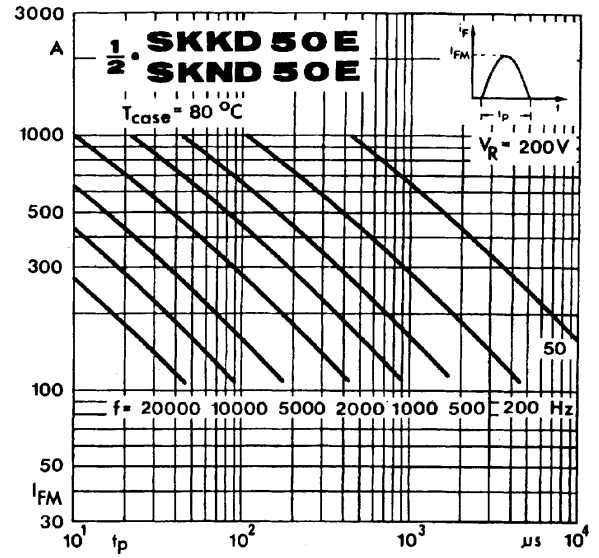

Fig. 12 b Rated sinusoidal peak forward current

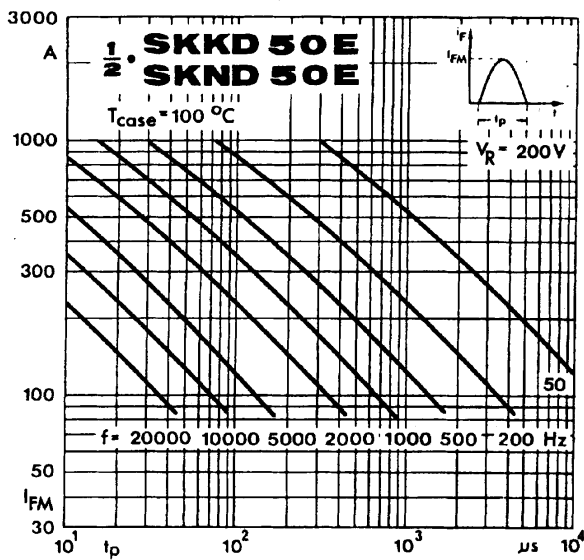

Fig. 12 c Rated sinusoidal peak forward current

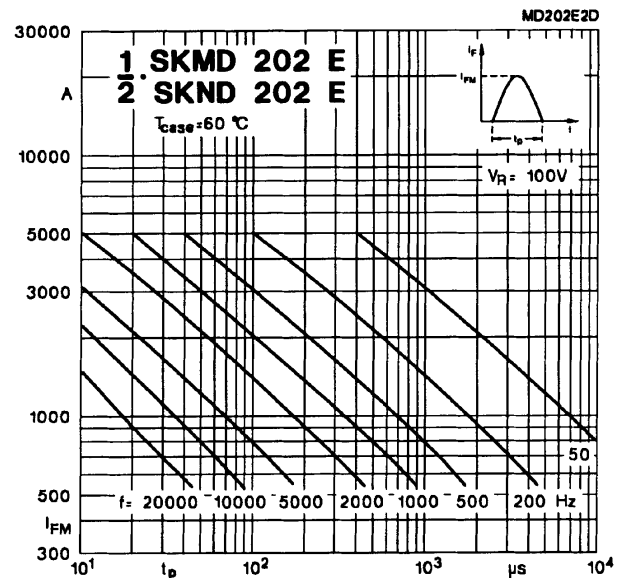

Fig. 12 d Rated sinusoidal peak forward current

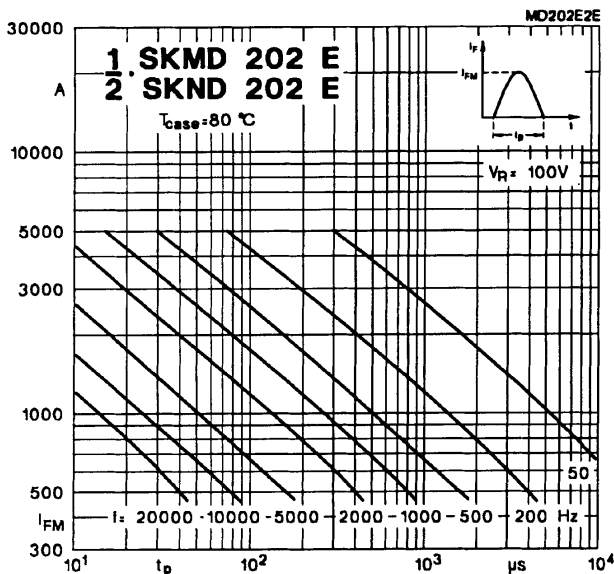

Fig. 12 e Rated sinusoidal peak forward current

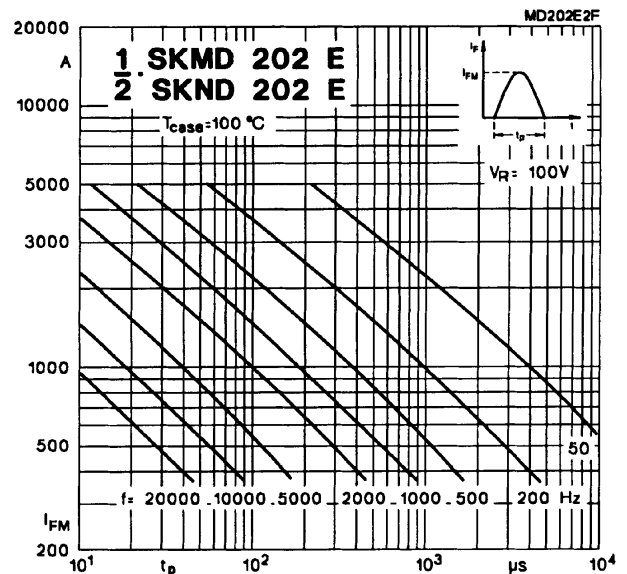

Fig. 12 f Rated sinusoidal peak forward current

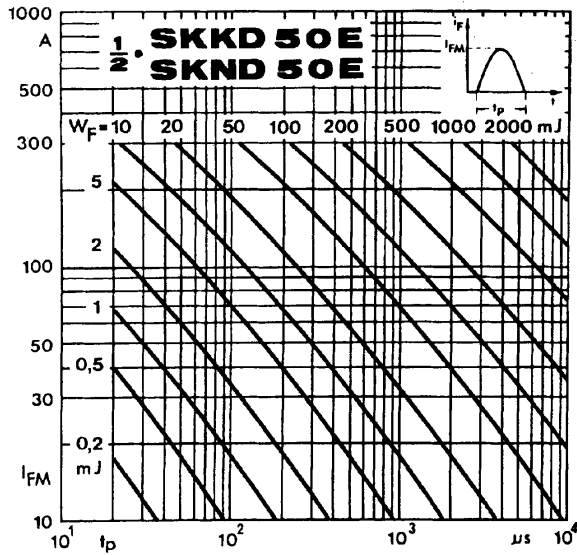

Fig. 13 a Forward energy dissipation, sinusoidal

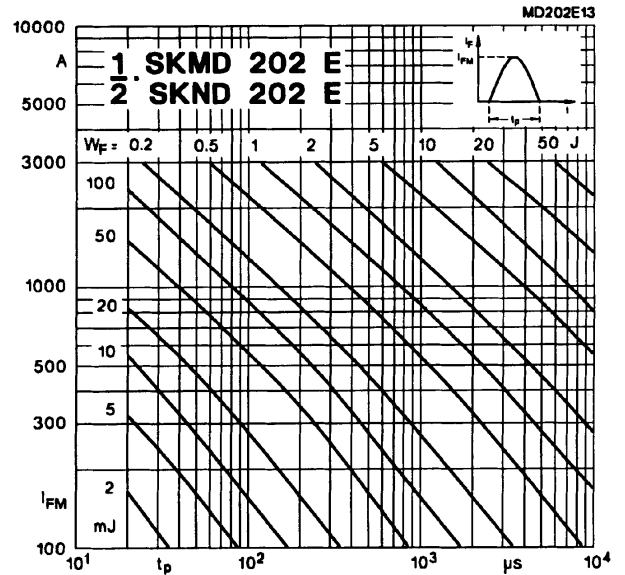

Fig. 13 b Forward energy dissipation, sinusoidal

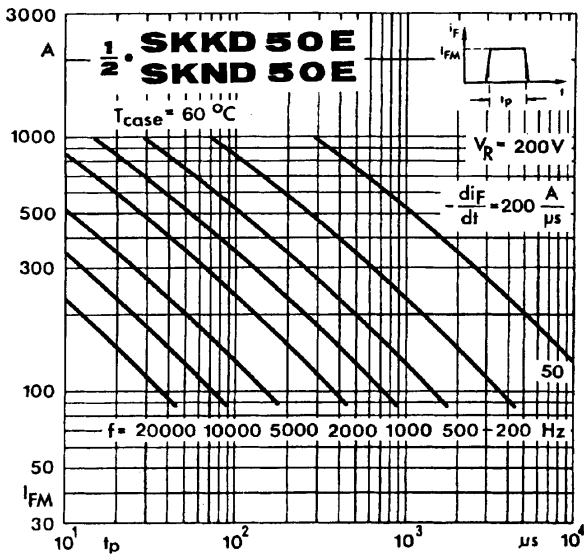

Fig. 14 a Rated rectangular peak forward current

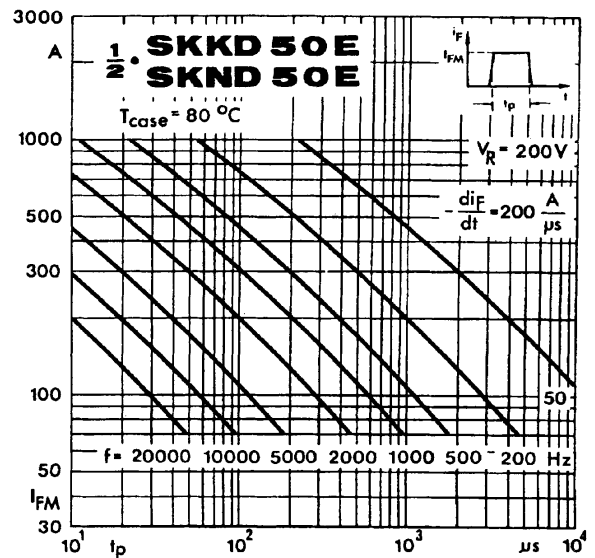

Fig. 14 b Rated rectangular peak forward current

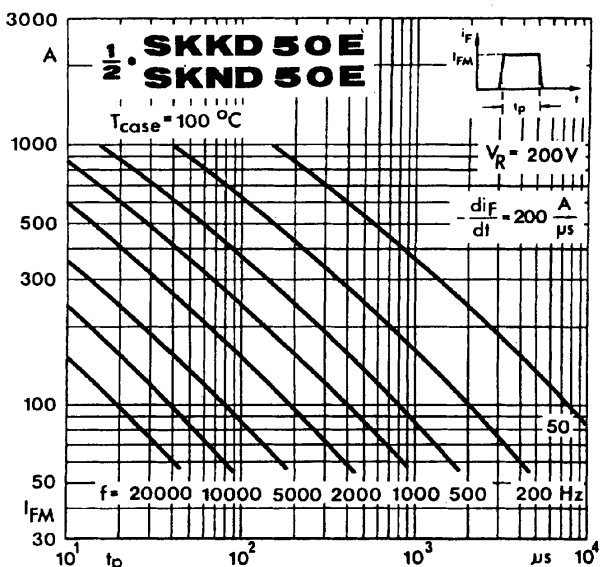

Fig. 14 c Rated rectangular peak forward current

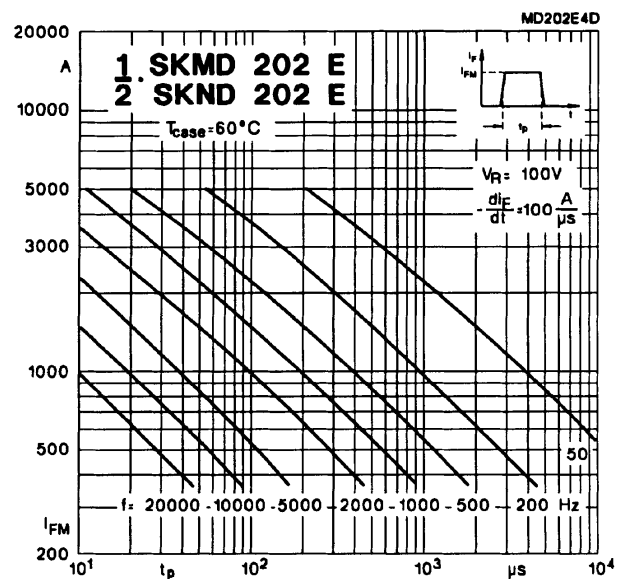

Fig. 14 d Rated rectangular peak forward current

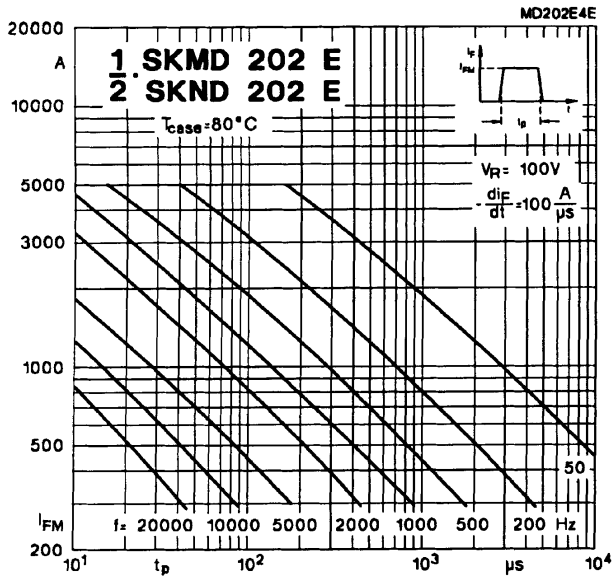

Fig. 14 e Rated rectangular peak forward current

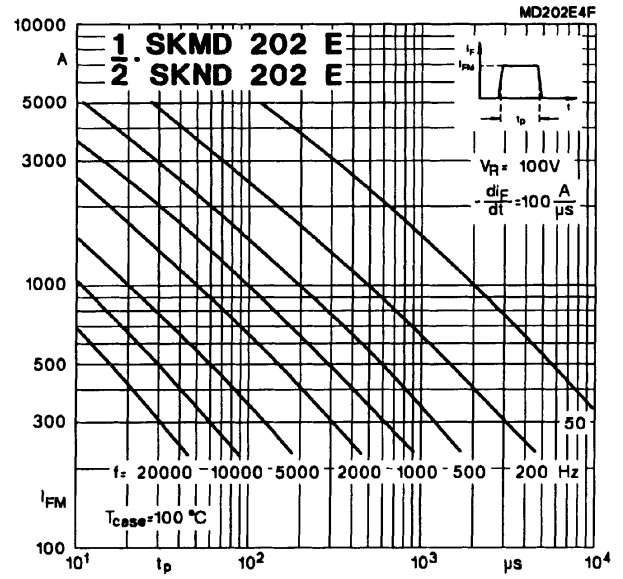

Fig. 14 f Rated rectangular peak forward current

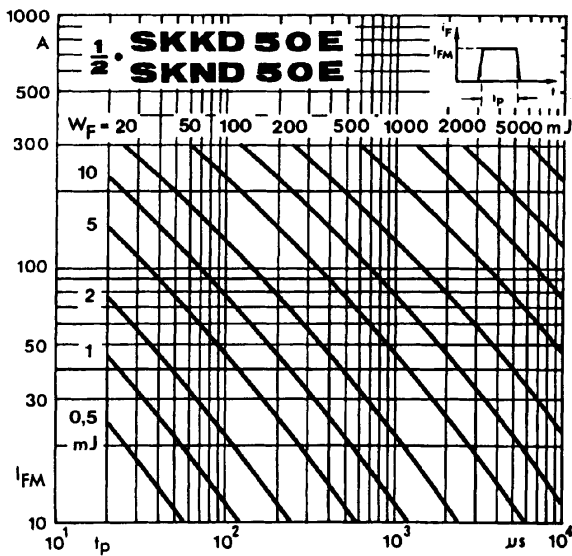

Fig. 15 a Forward energy dissipation, rectangular

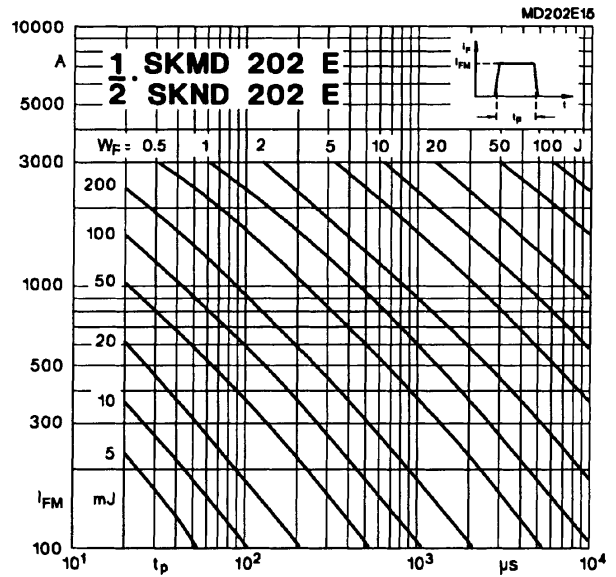

Fig. 15 b Forward energy dissipation, rectangular

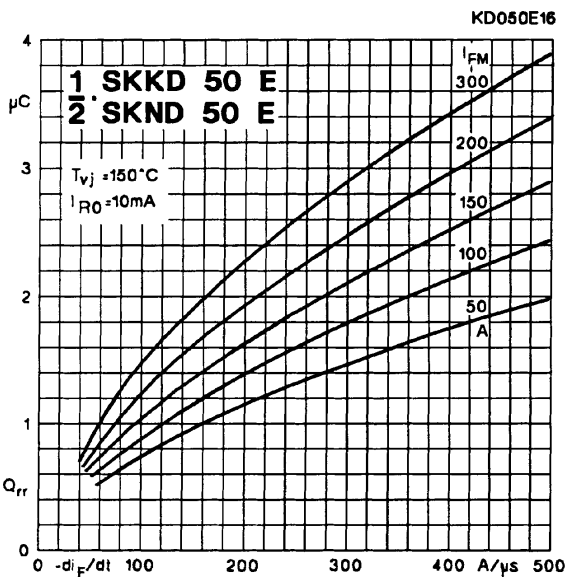

Fig. 16 a Recovered charge vs. current decrease

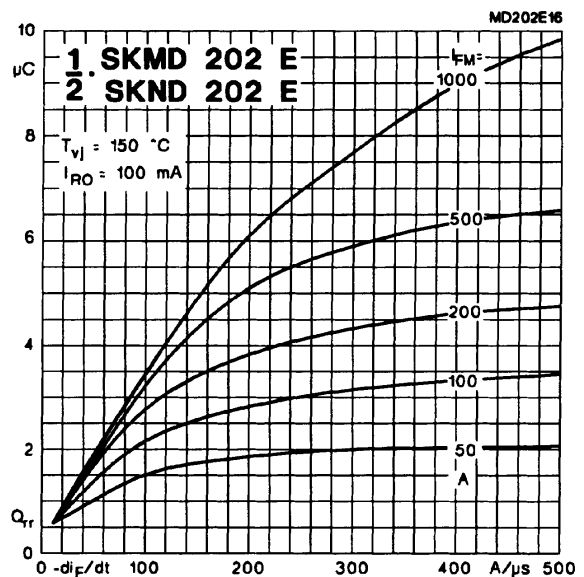

Fig. 16 b Recovered charge vs. current decrease

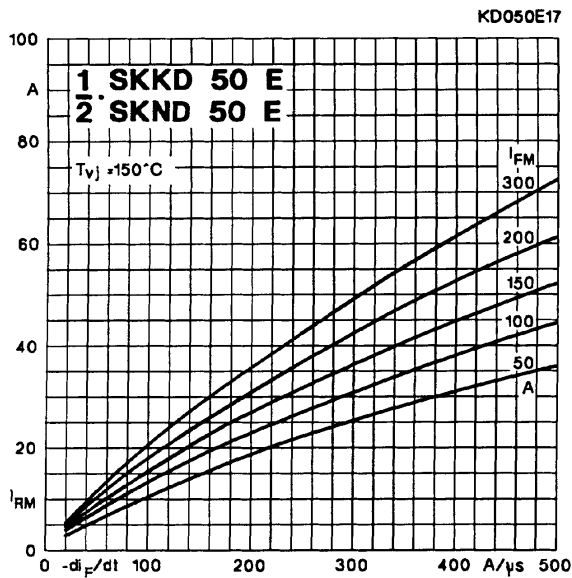

Fig. 17 a Peak recovery current vs. current decrease

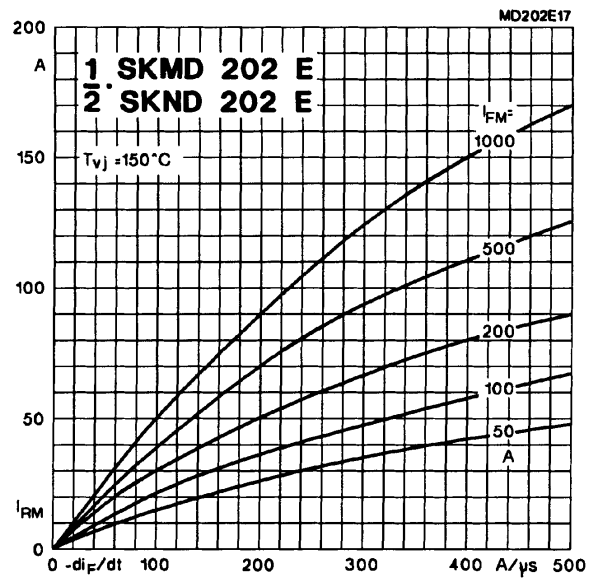

Fig. 17 b Peak recovery current vs. current decrease

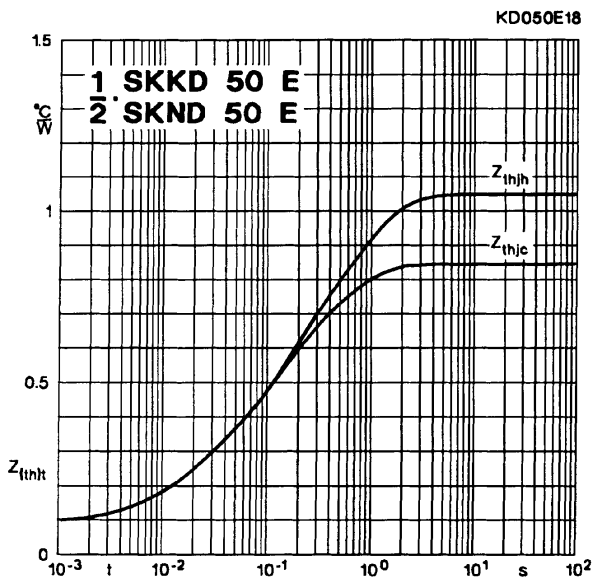

Fig. 18 a Transient thermal impedance vs. time

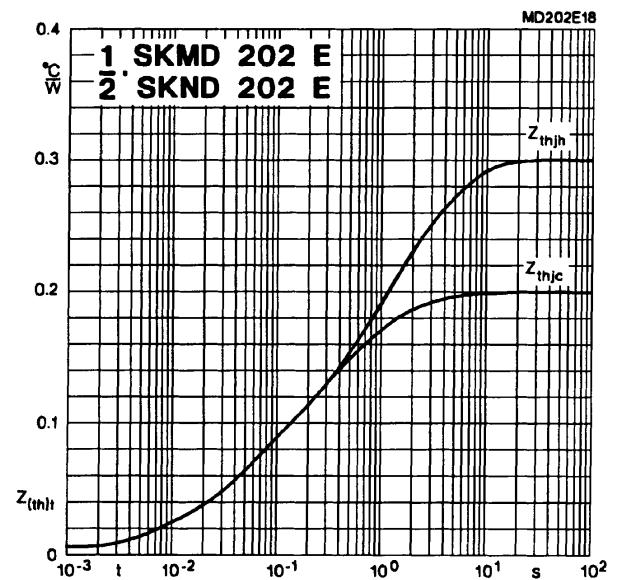

Fig. 18 b Transient thermal impedance vs. time

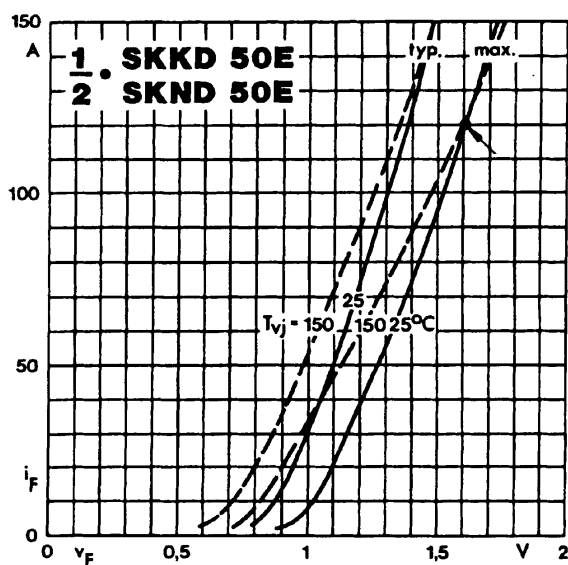

Fig. 19 a Forward characteristics

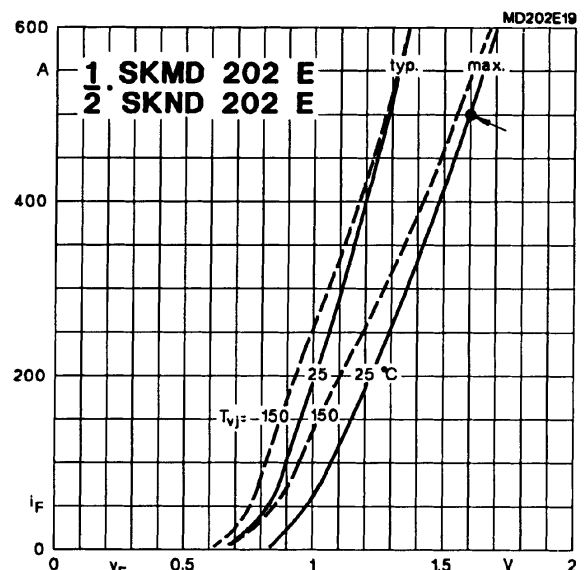

Fig. 19 b Forward characteristics

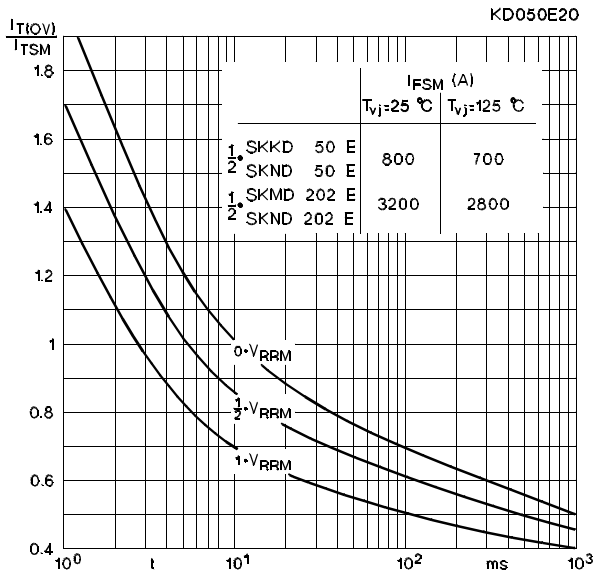
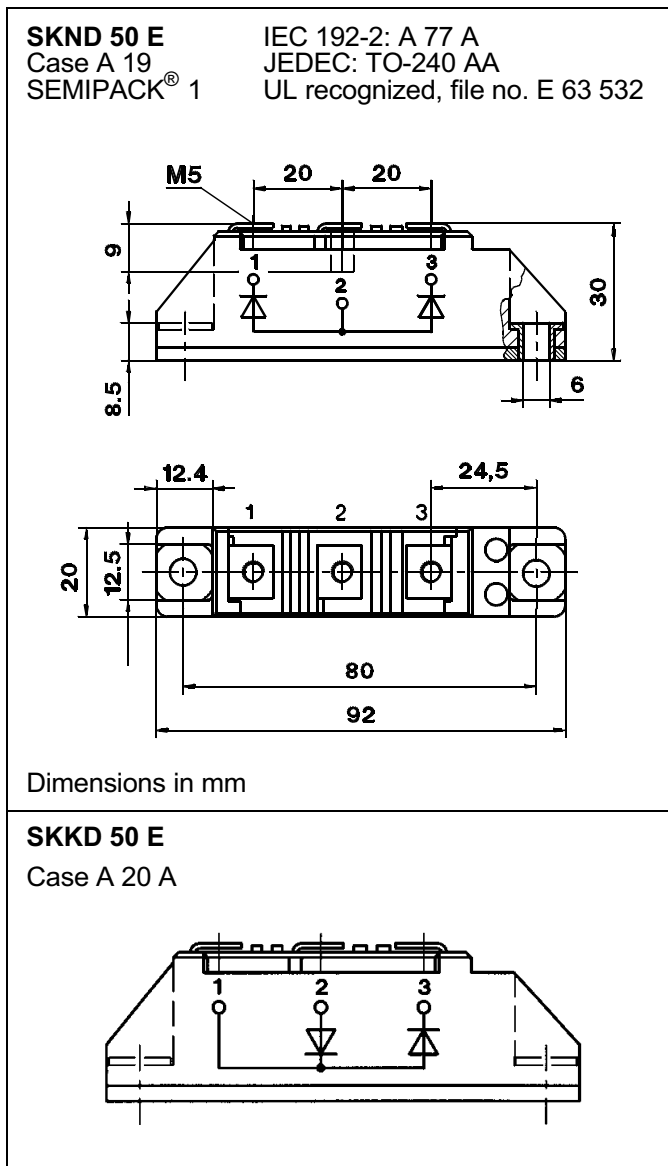

Fig. 20 Surge overload current vs. time



SKKD 105 F, 115 F

Case A 10

IEC 192-2: A 77 A
JEDEC: TO-240 AA

SEMIPACK® 1

UL recognized, file no. E 63 532

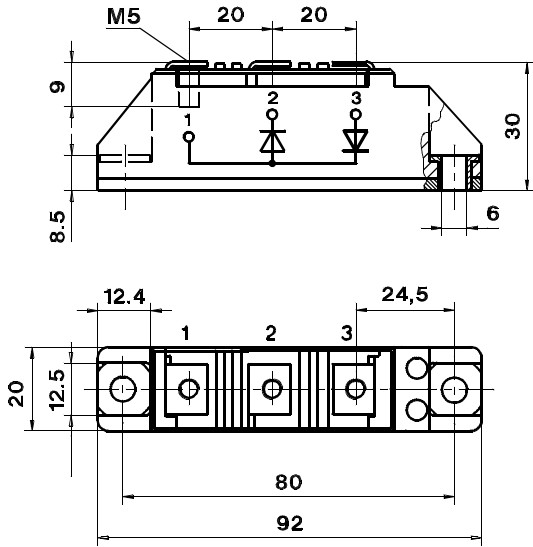

SKKD 60 F, 75 F

Case A 23

SEMIPACK® 2

UL recognized, file no. E 63 532

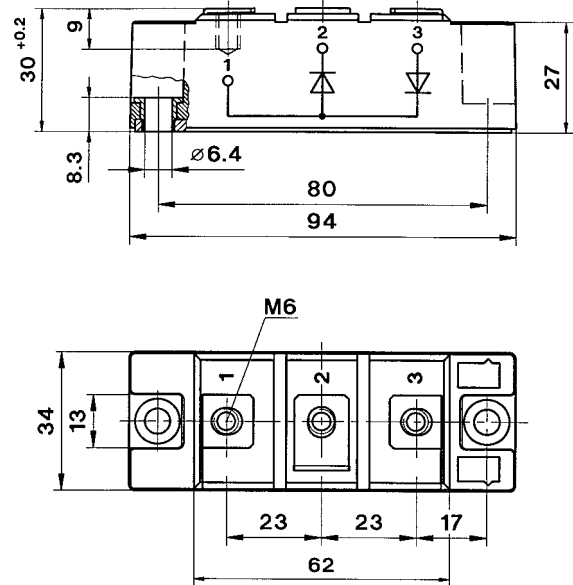

SKMD 105 F

Case A 33

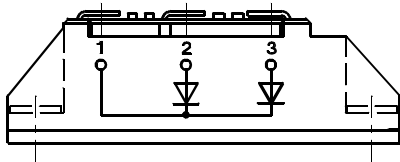

SKMD 150 F, 202 E

Case A 51

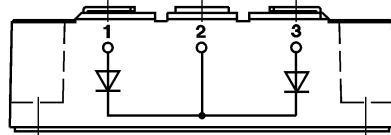

SKND 105 F

Case A 37

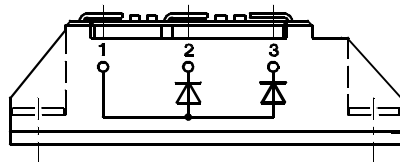

SKND 150 F, 202 E

Case A 52

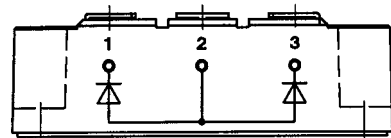

Dimensions in mm

SKKD 150 F, 170 F

Case A 53

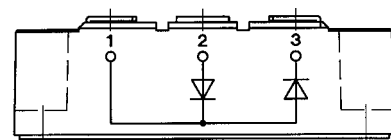

Dimensions in mm