

# SPECIFICATION

(75A/1700V-IGBT Module)

Device Name : IGBT Module  
(RoHS compliant product)

Type Name : 2MBI75VA-170-50

Spec. No. : MS5F7932

This material and the information herein is the property of Fuji Electric Co. Ltd. They shall be neither reproduced, copied, lent, or disclosed in any way whatsoever for the use of any third party nor used for the manufacturing purposes without the express written consent of Fuji Electric Co. Ltd.

	DATE	NAME	APPROVAL		
DRAWN	Dec.-21-'11	S. Horie		<b>Fuji Electric Co., Ltd.</b>	
CHECKED	Dec.-21-'11	S. Miyashita		DWG.No.	<b>MS5F7932</b>



**Type Name: 2MBI75VA-170-50 (RoHS compliant products)**

**1. Outline Drawing ( Unit : mm )**

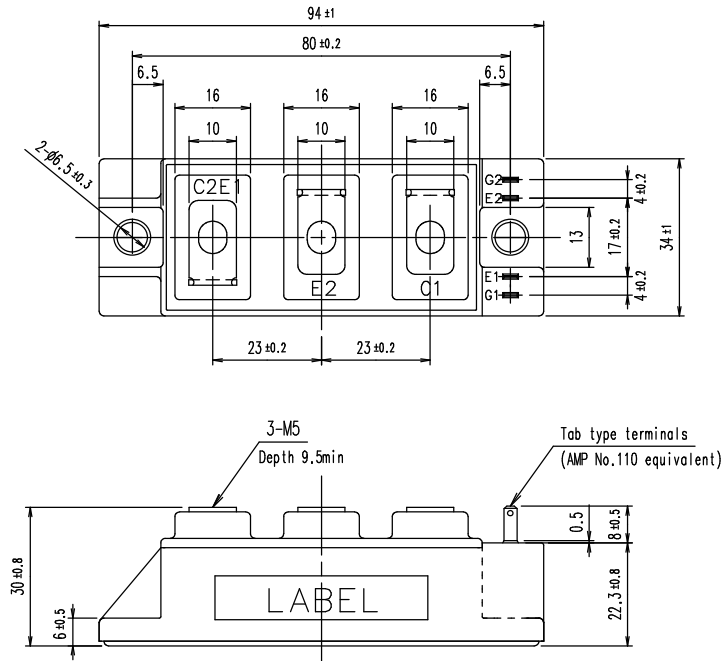

Weight: 180g (typ.)

**2. Equivalent Circuit**

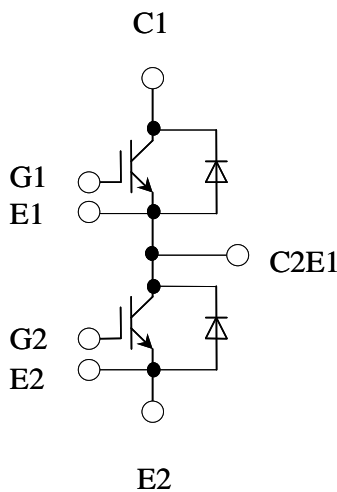

This material and the information herein is the property of Fuji Electric Co. Ltd. They shall be neither reproduced, copied, lent, or disclosed in any way whatsoever for the use of any third party nor used for the manufacturing purposes without the express written consent of Fuji Electric Co., Ltd.

### 3. Absolute Maximum Ratings (at Tc= 25°C unless otherwise specified)

Items		Symbols	Conditions	Maximum Ratings	Units
Collector-Emitter voltage		VCES		1700	V
Gate-Emitter voltage		VGES		±20	V
Collector current	Ic	Continuous	Tc=100°C	75	
			Tc=25°C	110	
	Ic pulse	1ms	150		
	-Ic		75		
	-Ic pulse	1ms		150	
Collector power dissipation		Pc	1 device	555	W
Junction temperature		Tj		175	°C
Operating junction temperature (under switching conditions)		Tjop		150	
Case temperature		Tc		125	
Storage temperature		Tstg		-40 ~ 125	
Isolation voltage	between terminal and copper base (*1)	Viso	AC: 1min.	4000	VAC
Screw Torque	Mounting (*2)	-		5.0	N m
	Terminals (*3)	-		5.0	

(\*1) All terminals should be connected together when isolation test will be done.

(\*2) Recommendable Value : 3.0 ~ 5.0 N·m (M5 or M6)

(\*3) Recommendable Value : 2.5 ~ 5.0 N·m (M5)

This material and the information herein is the property of Fuji Electric Co., Ltd. They shall be neither reproduced, copied, lent, or disclosed in any way whatsoever for the use of any third party nor used for the manufacturing purposes without the express written consent of Fuji Electric Co., Ltd.

#### 4. Electrical characteristics (at Tj= 25°C unless otherwise specified)

##### NOTICE:

The external gate resistance (Rg) shown below is one of our recommend value for the purpose of minimum switching loss. However the optimum Rg depends on circuit configuration and/or environment. We recommend that the Rg has to be carefully chosen based on consideration if IGBT module matches design criteria, for example, switching loss, EMC/EMI, spike voltage, surge current and no unexpected oscillation and so on.

Items	Symbols	Conditions	Characteristics			Units	
			min.	typ.	max.		
Zero gate voltage Collector current	ICES	VGE=0V, VCE=1700V	-	-	1.0	mA	
Gate-Emitter leakage current	IGES	VCE=0V, VGE=±20V	-	-	200	nA	
Gate-Emitter threshold voltage	VGE(th)	VCE=20V, Ic=75mA	6.0	6.5	7.0	V	
Collector-Emitter saturation voltage	VCE(sat) (terminal)	VGE=15V, Ic=75A	Tj=25°C	-	2.10	2.55	V
			Tj=125°C	-	2.55	-	
			Tj=150°C	-	2.60	-	
	VCE(sat) (chip)	VGE=15V, Ic=75A	Tj=25°C	-	2.00	2.45	
			Tj=125°C	-	2.40	-	
			Tj=150°C	-	2.45	-	
Internal gate resistance	Rg(int)	-	-	10	-		
Input capacitance	Cies	VCE=10V, VGE=0V, f=1MHz	-	8.2	-	nF	
Turn-on time	ton	Vcc=900V, Ic=75A, VGE=±15V, Rg=22Ω, Tj=150°C, Ls=30nH	-	1250	-	nsec	
	tr		-	550	-		
	tr(i)		-	70	-		
Turn-off time	toff		-	1300	-		
	tf		-	150	-		
			-				
Forward on voltage	VF (terminal)	VGE=0V, IF=75A	Tj=25°C	-	1.85	2.30	V
			Tj=125°C	-	2.10	-	
			Tj=150°C	-	2.10	-	
	VF (chip)	VGE=0V, IF=75A	Tj=25°C	-	1.80	2.25	
			Tj=125°C	-	2.05	-	
			Tj=150°C	-	2.05	-	
Reverse recovery time	trr	IF=75A	-	140	-	nsec	

#### 5. Thermal resistance characteristics

Items	Symbols	Conditions	Characteristics			Units
			min.	typ.	max.	
Thermal resistance(1 device)	Rth(j-c)	IGBT	-	-	0.27	°C/W
		FWD	-	-	0.48	
Contact thermal resistance (1 device) (*1)	Rth(c-f)	with Thermal Compound	-	0.050	-	

(\*1) This is the value which is defined mounting on the additional cooling fin with thermal compound.

#### 6. Recommend way of module mounting on Heat sink

- (1) Initial : 1/3 specified torque.
- (2) Final : Full specified torque (3.0 - 5.0 Nm).

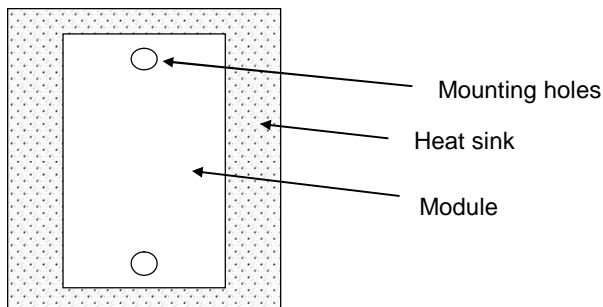

This material and the information herein is the property of Fuji Electric Co., Ltd. They shall be neither reproduced, copied, lent, or disclosed in any way whatsoever for the use of any third party nor used for the manufacturing purposes without the express written consent of Fuji Electric Co., Ltd.

This material and the information herein is the property of Fuji Electric Co., Ltd. They shall be neither reproduced, copied, lent, or disclosed in any way whatsoever for the use of any third party nor used for the manufacturing purposes without the express written consent of Fuji Electric Co., Ltd.

### 7. Indication on module

Display on the module label

- Logo of production
- Type name : 2MBI75VA-170-50
- IC, VCES rating : 75A 1700V
- Lot No. (5 digits)
- Place of manufacturing (code)
- Bar code

### 8. Applicable Category

This specification is applied to IGBT Module named 2MBI75VA-170-50.

### 9. Storage and transportation notes (保管・運搬上の注意事項)

- The module should be stored at a standard temperature of 5 to 35°C and humidity of 45 to 75% .  
 常温・常湿保存が望ましい。(5 ~ 35°C, 45 ~ 75%)
- Store modules in a place with few temperature changes in order to avoid condensation on the module surface.  
 急激な温度変化のなきこと。(モジュール表面が結露しないこと)
- Avoid exposure to corrosive gases and dust.  
 腐食性ガスの発生場所、塵埃の多い場所は避けること。
- Avoid excessive external force on the module.  
 製品に荷重がかからないように十分注意すること。
- Store modules with unprocessed terminals.  
 モジュールの端子は未加工の状態 で保管すること。
- Do not drop or otherwise shock the modules when transporting.  
 製品の運搬時に衝撃を与えたり、落下させたりしないこと。
- Do not pull the springs when transporting and handling.  
 製品の運搬時や取り扱い時にスプリングを引っ張らないこと。

### 10. Definitions of switching time

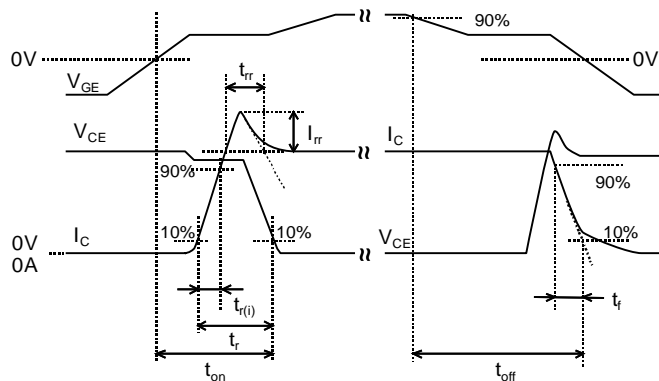
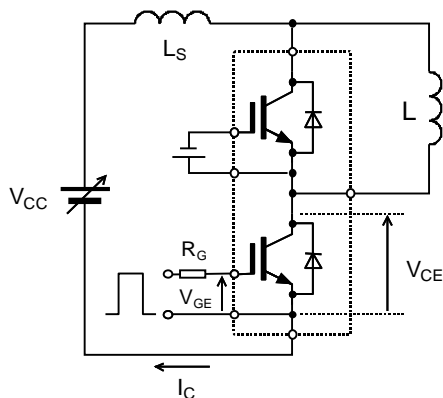

### 11. Packing and labeling

Display on the packing box

- Logo of production
- Type name
- Lot No
- Products quantity in a packing box

## 12. List of materials (材料リスト)

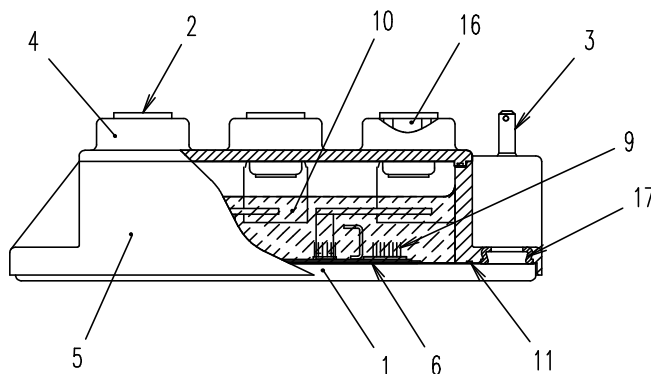

No.	Parts	Material (main)	Ref.
1	Base Plate	Cu	Ni plating
2	Main terminal	Cu	Ni plating
3	Sub terminal	Cu or Brass	Ni plating
4	Cover	PPS resin	UL 94V-0
5	Case	PPS resin	UL 94V-0
6	Isolation substrate	Al <sub>2</sub> O <sub>3</sub> + Cu	
7	IGBT chip	Silicon	(Not drawn in above)
8	FWD chip	Silicon	(Not drawn in above)
9	Wiring	Aluminum	
10	Silicone Gel	Silicone resin	
11	Adhesive	Silicone resin	
12	Solder (Under chip)	Sn / Ag base	(Not drawn in above)
13	Solder (Under terminal)	Sn / Ag base	(Not drawn in above)
14	Solder (Under Isolation substrate )	Sn / Sb	(Not drawn in above)
15	Label	PET	(Not drawn in above)
16	Nut	Fe	Trivalent Chromate treatment
17	Ring	Brass	

This material and the information herein is the property of Fuji Electric Co., Ltd. They shall be neither reproduced, copied, lent, or disclosed in any way whatsoever for the use of any third party nor used for the manufacturing purposes without the express written consent of Fuji Electric Co., Ltd.



13. Reliability test Items

**Reliability Test Items**

Test categories	Test items	Test methods and conditions	Reference norms EIAJ ED-4701 (Aug.-2001 edition)	Number of sample	Acceptance number
Mechanical Tests	1 Terminal Strength (Pull test)	Pull force : 20N (Control terminal) Test time : 10±1 sec.	Test Method 401 method	5	(0:1)
	2 Mounting Strength	Screw torque : 3.0 ~ 5.0 N·m (M5, M6) Test time : 10±1 sec.	Test Method 402 method	5	(0:1)
	3 Vibration	Range of frequency : 10 ~ 500Hz Sweeping time : 15 min. Acceleration : 100m/s <sup>2</sup> Sweeping direction : Each X,Y,Z axis Test time : 6 hr. (2hr./direction)	Test Method 403 Reference 1 Condition code B	5	(0:1)
	4 Shock	Maximum acceleration : 5000m/s <sup>2</sup> Pulse width : 1.0msec. Direction : Each X,Y,Z axis Test time : 3 times/direction	Test Method 404 Condition code B	5	(0:1)
Environment Tests	1 High Temperature Storage	Storage temp. : 125 ± 5 °C Test duration : 1000hr.	Test Method 201	5	(0:1)
	2 Low Temperature Storage	Storage temp. : -40 ± 5 °C Test duration : 1000hr.	Test Method 202	5	(0:1)
	3 Temperature Humidity Storage	Storage temp. : 85 ± 2 °C Relative humidity : 85 ± 5% Test duration : 1000hr.	Test Method 103 Test code C	5	(0:1)
	4 Unsaturated Pressurized Vapor	Test temp. : 120 ± 2 °C Test humidity : 85 ± 5% Test duration : 96hr.	Test Method 103 Test code E	5	(0:1)
	5 Temperature Cycle	Test temp. : Low temp. -40 ± 5 °C High temp. 125 ± 5 °C RT 5 ~ 35 °C Dwell time : High ~ RT ~ Low ~ RT 1hr. 0.5hr. 1hr. 0.5hr. Number of cycles : 100 cycles	Test Method 105	5	(0:1)
	6 Thermal Shock	Test temp. : High temp. 100 <sup>+0</sup> <sub>-5</sub> °C Used liquid : Water with ice and boiling water Dipping time : 5 min. per each temp. Transfer time : 10 sec. Number of cycles : 10 cycles	Test Method 307 method Condition code B	5	(0:1)

This material and the information herein is the property of Fuji Electric Co., Ltd. They shall be neither reproduced, copied, lent, or disclosed in any way whatsoever for the use of any third party nor used for the manufacturing purposes without the express written consent of Fuji Electric Co., Ltd.



### Reliability Test Items

Test categories	Test items	Test methods and conditions	Reference norms EIAJ ED-4701 (Aug.-2001 edition)	Number of sample	Acceptance number
Endurance Tests	1 High temperature Reverse Bias (for Collector - Emitter)	Test temp. : $T_j = 150$ (-0 /+5 ) Bias Voltage : $V_C = 0.8 \times V_{CES}$ Bias Method : Applied DC voltage to C-E $V_{GE} = 0V$ Test duration : 1000hr.	Test Method 101	5	(0 : 1)
	2 High temperature Bias (for gate)	Test temp. : $T_j = 150$ (-0 /+5 ) Bias Voltage : $V_C = V_{GE} = +20V$ or $-20V$ Bias Method : Applied DC voltage to G-E $V_{CE} = 0V$ Test duration : 1000hr.	Test Method 101	5	(0 : 1)
	3 Temperature Humidity Bias	Test temp. : $85 \pm 2$ °C Relative humidit : $85 \pm 5\%$ Bias Voltage : $V_C = 0.8 \times V_{CES}$ Bias Method : Applied DC voltage to C-E $V_{GE} = 0V$ Test duration : 1000hr.	Test Method 102 Condition code C	5	(0 : 1)
	4 Intermitted Operating Life (Power cycle) ( for IGBT )	ON time : 2 sec. OFF time : 18 sec. Test temp. : $100 \pm 5$ deg $T_j$ 150 , $T_a = 25 \pm 5$ No. of cycles : 15000 cycles	Test Method 106	5	(0 : 1)

### Failure Criteria

Item	Characteristic	Symbol	Failure criteria		Unit	Note	
			Lower limit	Upper limit			
Electrical characteristic	Leakage current	ICES	-	USLx2	mA		
		$\pm I_{GES}$	-	USLx2	$\mu A$		
	Gate threshold voltage	$V_{GE(th)}$	LSLx0.8	USLx1.2	mA		
	Saturation voltage	$V_{CE(sat)}$	-	USLx1.2	V		
	Forward voltage	VF	-	USLx1.2	V		
	Thermal resistance	IGBT	$\Delta V_{GE}$ or $\Delta V_{CE}$	-	USLx1.2	mV	
		FWD	$\Delta V_F$	-	USLx1.2	mV	
	Isolation voltage	Viso	Broken insulation		-		
Visual inspection	Visual inspection ┌ Peeling ├ Plating └ and the others	-	The visual sample		-		

Note :

LSL : Lower specified limit.  
USL : Upper specified limit.

Each parameter measurement read-outs shall be made after stabilizing the components at room ambient for 2 hours minimum, 24 hours maximum after removal from the tests. And in case of the wetting tests, for example, moisture resistance tests, each component shall be made wipe or dry completely before the measurement.

### Reliability Test Results

Test categories	Test items	Reference norms EIAJ ED-4701	Number of test sample	Number of failure sample
Mechanical Tests	1 Terminal Strength (Pull test)	Test Method 401 Method	5	0
	2 Mounting Strength	Test Method 402 method	5	0
	3 Vibration	Test Method 403 Condition code B	5	0
	4 Shock	Test Method 404 Condition code B	5	0
	5 Solderability	Test Method 303 Condition code A	5	0
	6 Resistance to Soldering Heat	Test Method 302 Condition code A	5	0
Environment Tests	1 High Temperature Storage	Test Method 201	5	0
	2 Low Temperature Storage	Test Method 202	5	0
	3 Temperature Humidity Storage	Test Method 103 Test code C	5	0
	4 Unsaturated Pressurized Vapor	Test Method 103 Test code E	5	0
	5 Temperature Cycle	Test Method 105	5	0
	6 Thermal Shock	Test Method 307 method Condition code A	5	0
Endurance Tests	1 High temperature Reverse Bias	Test Method 101	5	0
	2 High temperature Bias ( for gate )	Test Method 101	5	0
	3 Temperature Humidity Bias	Test Method 102 Condition code C	5	0
	4 Intermitted Operating Life (Power cycling) ( for IGBT )	Test Method 106	5	0

This material and the information herein is the property of Fuji Electric Co., Ltd. They shall be neither reproduced, copied, lent, or disclosed in any way whatsoever for the use of any third party nor used for the manufacturing purposes without the express written consent of Fuji Electric Co., Ltd.

This material and the information herein is the property of Fuji Electric Co., Ltd. They shall be neither reproduced, copied, lent, or disclosed in any way whatsoever for the use of any third party nor used for the manufacturing purposes without the express written consent of Fuji Electric Co., Ltd.

Collector current vs. Collector-Emitter voltage (typ.)  
T<sub>j</sub>= 25°C / chip

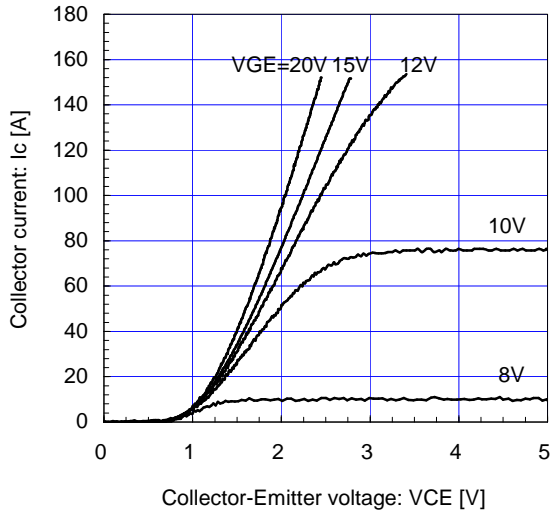

Collector current vs. Collector-Emitter voltage (typ.)  
T<sub>j</sub>= 150°C / chip

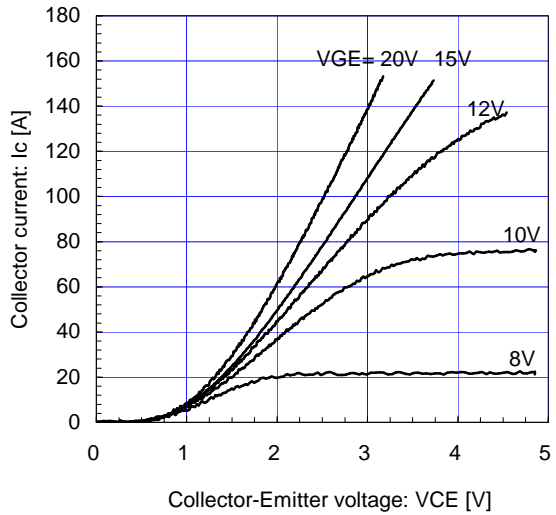

Collector current vs. Collector-Emitter voltage (typ.)  
VGE= 15V / chip

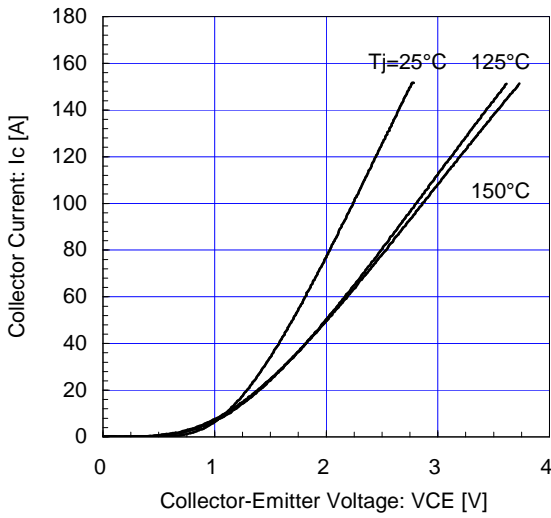

Collector-Emitter voltage vs. Gate-Emitter voltage  
T<sub>j</sub>= 25°C / chip

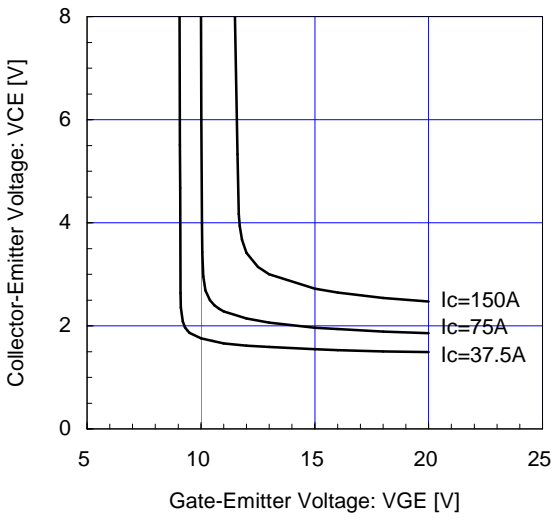

Gate Capacitance vs. Collector-Emitter Voltage  
VGE= 0V, f= 1MHz, T<sub>j</sub>= 25°C

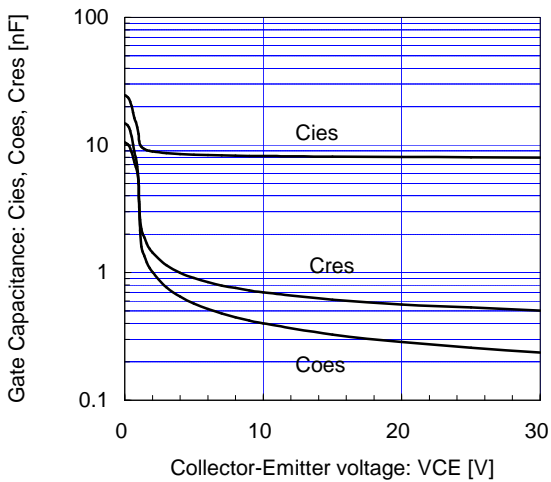

Dynamic Gate Charge (typ.)  
V<sub>cc</sub>=900V, Ic=75A, T<sub>j</sub>= 25°C

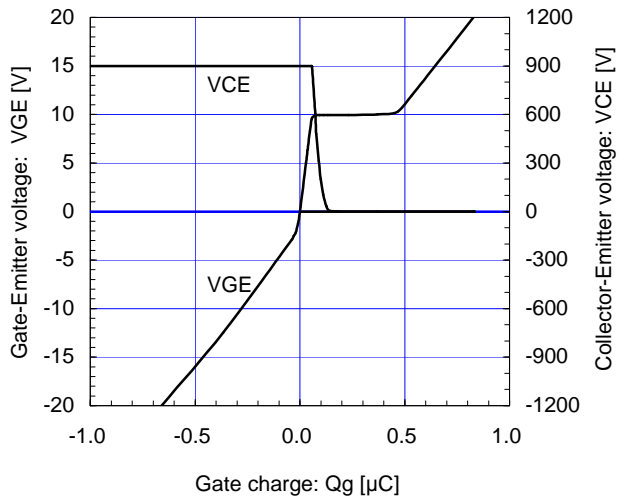

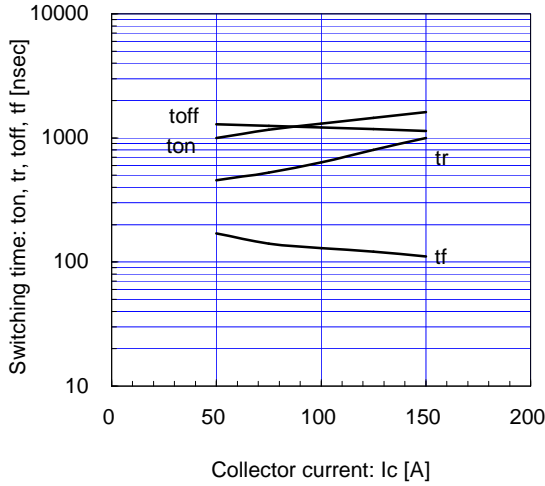

This material and the information herein is the property of Fuji Electric Co., Ltd. They shall be neither reproduced, copied, lent, or disclosed in any way whatsoever for the use of any third party nor used for the manufacturing purposes without the express written consent of Fuji Electric Co., Ltd.

Switching time vs. Collector current (typ.)  
 $V_{cc}=900V, V_{GE}=\pm 15V, R_g=22\Omega, T_j=125^\circ C$

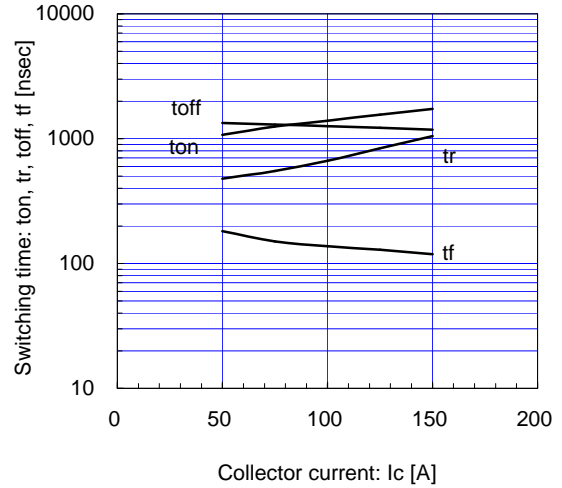

Switching time vs. Collector current (typ.)  
 $V_{cc}=900V, V_{GE}=\pm 15V, R_g=22\Omega, T_j=150^\circ C$



Switching time vs. Gate resistance (typ.)  
 $V_{cc}=900V, I_c=75A, V_{GE}=\pm 15V, T_j=125^\circ C$

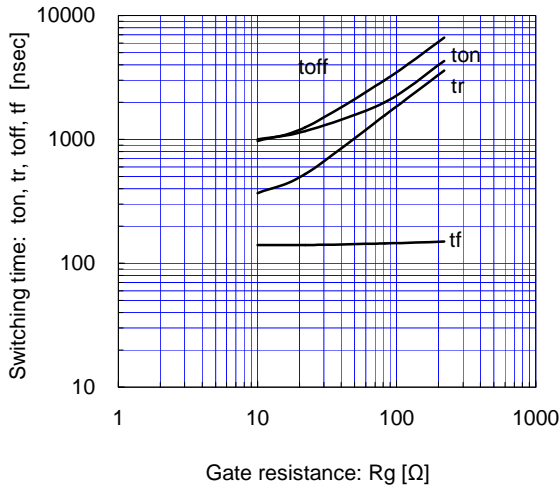

Switching loss vs. Collector current (typ.)  
 $V_{cc}=900, V_{GE}=\pm 15V, R_g=22\Omega, T_j=125, 150^\circ C$

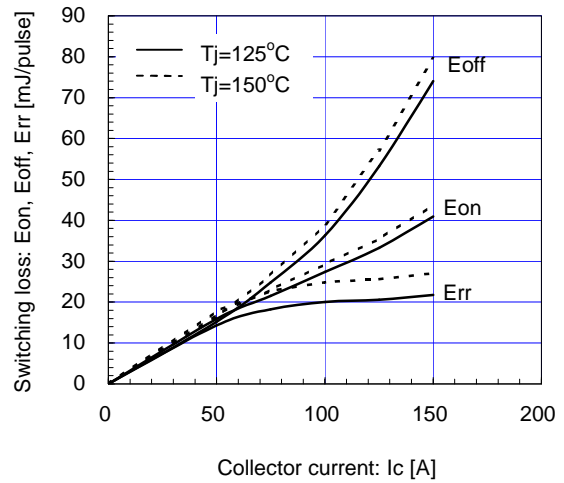

Switching loss vs. Gate resistance (typ.)  
 $V_{cc}=900V, I_c=75A, V_{GE}=\pm 15V, T_j=125, 150^\circ C$

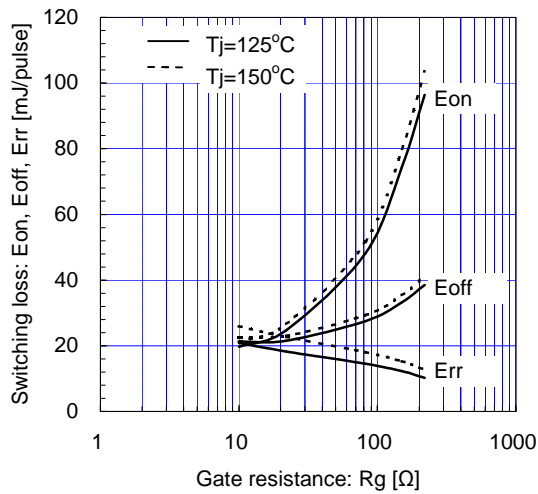

Reverse bias safe operating area (max.)  
 $+V_{GE}=15V, -V_{GE}=15V, R_g=22\Omega, T_j=150^\circ C$

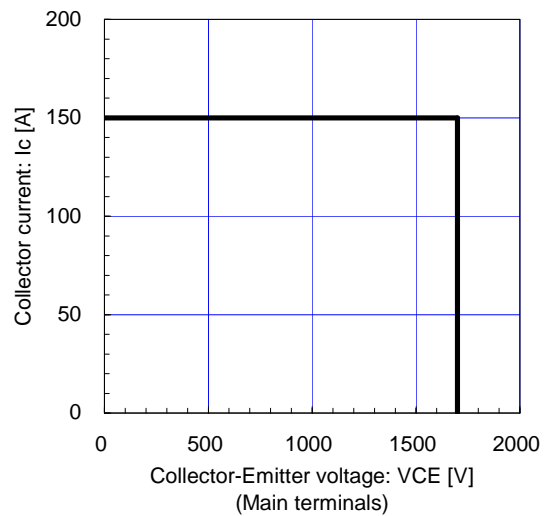

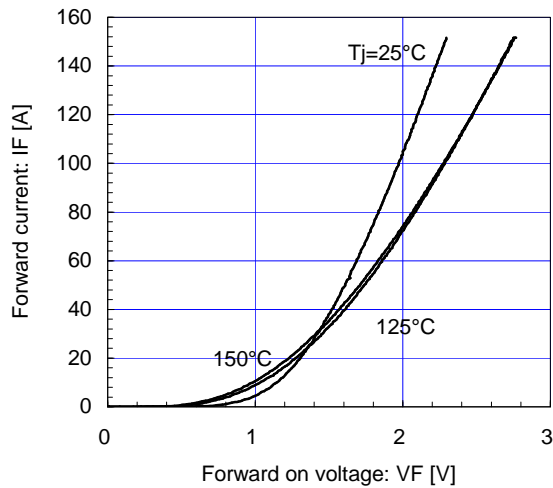

This material and the information herein is the property of Fuji Electric Co., Ltd. They shall be neither reproduced, copied, lent, or disclosed in any way whatsoever for the use of any third party nor used for the manufacturing purposes without the express written consent of Fuji Electric Co., Ltd.

Forward Current vs. Forward Voltage (typ.)  
chip

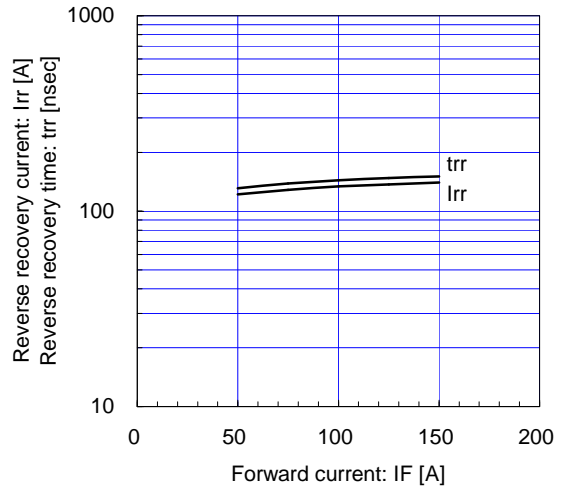

Reverse Recovery Characteristics (typ.)  
Vcc=900V, VGE=±15V, Rg=22Ω, Tj=125°C



Reverse Recovery Characteristics (typ.)  
Vcc=900V, VGE=±15V, Rg=22Ω, Tj=150°C

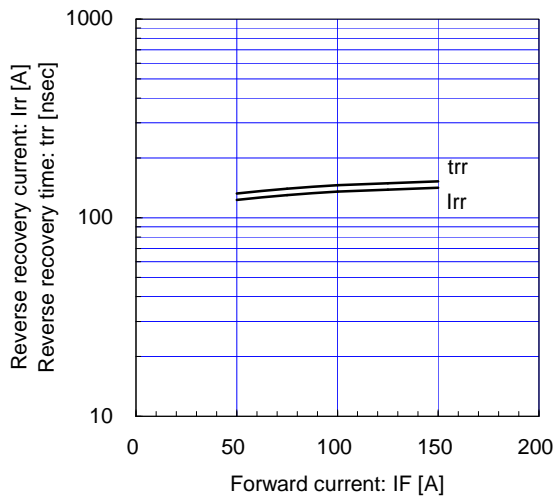

Transient Thermal Resistance (max.)

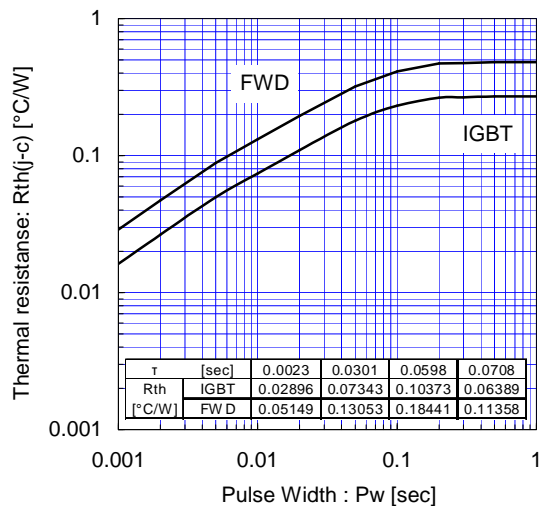

FWD safe operating area (max.)  
Tj=150°C

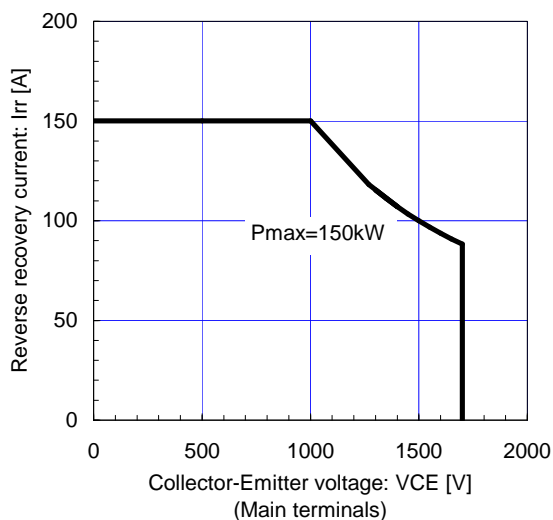

## Warnings

- This product shall be used within its maximum rating (voltage, current, and temperature). This product may be broken in case of using beyond the maximum ratings.  
 製品の最大定格 (電圧, 電流, 温度等) の範囲内で御使用下さい。最大定格を超えて使用すると、素子が破壊する場合があります。
- Connect adequate fuse or protector of circuit between three-phase line and this product to prevent the equipment from causing secondary destruction, such as fire, its spreading, or explosion.  
 万一の不慮の事故で素子が破壊した場合を考慮し、商用電源と本製品の間に適切な容量のヒューズ又はブレーカーを必ず付けて火災、爆発、延焼等の2次破壊を防いでください。
- Use this product after realizing enough working on environment and considering of product's reliability life. This product may be broken before target life of the system in case of using beyond the product's reliability life.  
 製品の使用環境を十分に把握し、製品の信頼性寿命が満足できるか検討の上、本製品を適用して下さい。製品の信頼性寿命を超えて使用した場合、装置の目標寿命より前に素子が破壊する場合があります。
- If the product had been used in the environment with acid, organic matter, and corrosive gas ( hydrogen sulfide, sulfurous acid gas), the product's performance and appearance can not be ensured easily.  
 酸・有機物・腐食性ガス (硫化水素, 亜硫酸ガス等) を含む環境下で使用された場合、製品機能・外観等の保証はできません。
- Use this product within the power cycle curve (Technical Rep.No. : MT5F12959). Power cycle capability is classified to delta-Tj mode which is stated as above and delta-Tc mode. Delta-Tc mode is due to rise and down of case temperature (Tc), and depends on cooling design of equipment which use this product. In application which has such frequent rise and down of Tc, well consideration of product life time is necessary.  
 本製品は、パワーサイクル寿命カーブ以下で使用下さい(技術資料No.: MT5F12959)。パワーサイクル耐量にはこの $\Delta T_j$  による場合の他に、 $\Delta T_c$ による場合があります。これはケース温度( $T_c$ )の上昇下降による熱ストレスであり、本製品をご使用する際の放熱設計に依存します。ケース温度の上昇下降が頻繁に起こる場合は、製品寿命に十分留意してご使用下さい。
- Never add mechanical stress to deform the main or control terminal. The deformed terminal may cause poor contact problem.  
 主端子及び制御端子に応力を与えて変形させないで下さい。端子の変形により、接触不良などを引き起こす場合があります。
- Use this product with keeping the cooling fin's flatness between screw holes within 50 $\mu$ m at 100mm and the roughness within 10 $\mu$ m. Also keep the tightening torque within the limits of this specification. Too large convex of cooling fin may cause isolation breakdown and this may lead to a critical accident. On the other hand, too large concave of cooling fin makes gap between this product and the fin bigger, then, thermal conductivity will be worse and over heat destruction may occur.  
 冷却フィンにネジ取り付け位置間で平坦度を100mmで50 $\mu$ m以下、表面の粗さは10 $\mu$ m以下にして下さい。過大な凸反りがあったりすると本製品が絶縁破壊を起こし、重大事故に発展する場合があります。また、過大な凹反りやゆがみ等があると、本製品と冷却フィンの間には空隙が生じて放熱が悪くなり、熱破壊に繋がる場合があります。
- In case of mounting this product on cooling fin, use thermal compound to secure thermal conductivity. If the thermal compound amount was not enough or its applying method was not suitable, its spreading will not be enough, then, thermal conductivity will be worse and thermal run away destruction may occur.  
 Confirm spreading state of the thermal compound when its applying to this product.  
 (Spreading state of the thermal compound can be confirmed by removing this product after mounting.)  
 素子を冷却フィンに取り付ける際には、熱伝導を確保するためのコンパウンド等をご使用ください。又、塗布量が不足したり、塗布方法が不適だったりすると、コンパウンドが十分に素子全体に広がらず、放熱悪化による熱破壊に繋がる事があります。  
 コンパウンドを塗布する際には、製品全面にコンパウンドが広がっている事を確認してください。  
 ( 実装した後に素子を取りはずすとコンパウンドの広がり具合を確認する事が出来ます。 )
- It shall be confirmed that IGBT's operating locus of the turn-off voltage and current are within the RBSOA specification. This product may be broken if the locus is out of the RBSOA.  
 ターンオフ電圧・電流の動作軌跡がRBSOA仕様内にあることを確認して下さい。RBSOAの範囲を超えて使用すると素子が破壊する可能性があります。

This material and the information herein is the property of Fuji Electric Co., Ltd. They shall be neither reproduced, copied, lent, or disclosed in any way whatsoever for the use of any third party nor used for the manufacturing purposes without the express written consent of Fuji Electric Co., Ltd.

## Warnings

- If excessive static electricity is applied to the control terminals, the devices may be broken. Implement some countermeasures against static electricity.  
制御端子に過大な静電気が印加された場合、素子が破壊する場合があります。取り扱い時は静電気対策を実施して下さい。
- Never add the excessive mechanical stress to the main or control terminals when the product is applied to equipments. The module structure may be broken.  
素子を装置に実装する際に、主端子や制御端子に過大な応力を与えないで下さい。端子構造が破壊する可能性があります。
- In case of insufficient -VGE, erroneous turn-on of IGBT may occur. -VGE shall be set enough value to prevent this malfunction. (Recommended value : -VGE = -15V)  
逆バイアスゲート電圧-VGEが不足しますと誤点弧を起こす可能性があります。誤点弧を起こさない為に-VGEは十分な値で設定して下さい。(推奨値 : -VGE = -15V)
- In case of higher turn-on dv/dt of IGBT, erroneous turn-on of opposite arm IGBT may occur. Use this product in the most suitable drive conditions, such as +VGE, -VGE, RG, CGE to prevent the malfunction.  
ターンオン dv/dt が高いと対向アームのIGBTが誤点弧を起こす可能性があります。誤点弧を起こさない為の最適なドライブ条件(+VGE, -VGE, RG, CGE)でご使用下さい。
- This product may be broken by avalanche in case of VCE beyond maximum rating VCES is applied between C-E terminals. Use this product within its maximum voltage.  
VCESを超えた電圧が印加された場合、アバランシェを起こして素子破壊する場合があります。VCEは必ず最大定格の範囲内でご使用下さい。
- This product is designed for single connection.  
If the product is used for parallel connection without confirmation of Co.Ltd., the product performance cannot be ensured.  
この製品は、シングル専用設計です。  
パラレル接続での使用を富士電機への確認なく行った場合、製品の保証はできません。

## Cautions

- Fuji Electric is constantly making every endeavor to improve the product quality and reliability. However, semiconductor products may rarely happen to fail or malfunction. To prevent accidents causing injury or death, damage to property like by fire, and other social damage resulted from a failure or malfunction of the Fuji Electric semiconductor products, take some measures to keep safety such as redundant design, spread-fire-preventive design, and malfunction-protective design.  
富士電機は絶えず製品の品質と信頼性の向上に努めています。しかし、半導体製品は故障が発生したり、誤動作する場合があります。富士電機製半導体製品の故障または誤動作が、結果として人身事故・火災等による財産に対する損害や社会的な損害を起こさないように冗長設計・延焼防止設計・誤動作防止設計など安全確保のための手段を講じて下さい。
- The application examples described in this specification only explain typical ones that used the Fuji Electric products. This specification never ensure to enforce the industrial property and other rights, nor license the enforcement rights.  
本仕様書に記載してある応用例は、富士電機製品を使用した代表的な応用例を説明するものであり、本仕様書によって工業所有権、その他権利の実施に対する保障または実施権の許諾を行うものではありません。
- The product described in this specification is not designed nor made for being applied to the equipment or systems used under life-threatening situations. When you consider applying the product of this specification to particular used, such as vehicle-mounted units, shipboard equipment, aerospace equipment, medical devices, atomic control systems and submarine relaying equipment or systems, please apply after confirmation of this product to be satisfied about system construction and required reliability.  
本仕様書に記載された製品は、人命にかかわるような状況下で使用される機器あるいはシステムに用いられることを目的として設計・製造されたものではありません。本仕様書の製品を車両機器、船舶、航空宇宙、医療機器、原子力制御、海底中継機器あるいはシステムなど、特殊用途へのご利用をご検討の際は、システム構成及び要求品質に満足することをご確認の上、ご利用下さい。

If there is any unclear matter in this specification, please contact Fuji Electric Co.,Ltd.

**Fuji Electric Co., Ltd.**

DWG No.

**MS5F7932**

15 / 15