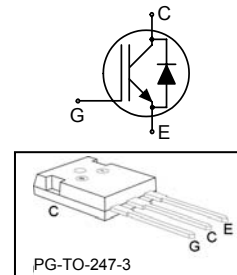


## High Speed IGBT in NPT-technology

- 30% lower  $E_{off}$  compared to previous generation
- Short circuit withstand time – 10  $\mu$ s
- Designed for operation above 30 kHz
- NPT-Technology for 600V applications offers:
  - parallel switching capability
  - moderate  $E_{off}$  increase with temperature
  - very tight parameter distribution
- High ruggedness, temperature stable behaviour
- Pb-free lead plating; RoHS compliant
- Qualified according to JEDEC<sup>1</sup> for target applications
- Complete product spectrum and PSpice Models : <http://www.infineon.com/igbt/>



Type	$V_{CE}$	$I_C$	$E_{off}$	$T_j$	Marking	Package
SKW30N60HS	600V	30	480 $\mu$ J	150 $^{\circ}$ C	K30N60HS	PG-TO-247-3

### Maximum Ratings

Parameter	Symbol	Value	Unit
Collector-emitter voltage	$V_{CE}$	600	V
DC collector current	$I_C$	41	A
$T_C = 25^{\circ}$ C		30	
$T_C = 100^{\circ}$ C			
Pulsed collector current, $t_p$ limited by $T_{jmax}$	$I_{Cpuls}$	112	
Turn off safe operating area	-	112	
$V_{CE} \leq 600V, T_j \leq 150^{\circ}$ C			
Diode forward current	$I_F$	41	
$T_C = 25^{\circ}$ C		28	
$T_C = 100^{\circ}$ C			
Diode pulsed current, $t_p$ limited by $T_{jmax}$	$I_{Fpuls}$	112	
Gate-emitter voltage static	$V_{GE}$	$\pm 20$	V
transient ( $t_p < 1\mu$ s, $D < 0.05$ )		$\pm 30$	
Short circuit withstand time <sup>2)</sup>	$t_{SC}$	10	$\mu$ s
$V_{GE} = 15V, V_{CC} \leq 600V, T_j \leq 150^{\circ}$ C			
Power dissipation	$P_{tot}$	250	W
$T_C = 25^{\circ}$ C			
Operating junction and storage temperature	$T_j, T_{stg}$	-55...+150	$^{\circ}$ C
Time limited operating junction temperature for $t < 150$ h	$T_{j(tl)}$	175	
Soldering temperature, 1.6mm (0.063 in.) from case for 10s	-	260	

<sup>1</sup> J-STD-020 and JESD-022

<sup>2)</sup> Allowed number of short circuits: <1000; time between short circuits: >1s.

**Thermal Resistance**

Parameter	Symbol	Conditions	Max. Value	Unit
<b>Characteristic</b>				
IGBT thermal resistance, junction – case	$R_{thJC}$		0.5	K/W
Diode thermal resistance, junction – case	$R_{thJCD}$		1.29	
Thermal resistance, junction – ambient	$R_{thJA}$		40	

**Electrical Characteristic, at  $T_j = 25^\circ\text{C}$ , unless otherwise specified**

Parameter	Symbol	Conditions	Value			Unit
			min.	Typ.	max.	
<b>Static Characteristic</b>						
Collector-emitter breakdown voltage	$V_{(BR)CES}$	$V_{GE}=0V, I_C=500\mu A$	600	-	-	V
Collector-emitter saturation voltage	$V_{CE(sat)}$	$V_{GE} = 15V, I_C=30A$ $T_j=25^\circ\text{C}$ $T_j=150^\circ\text{C}$		2.8 3.5	3.15 4.00	
Diode forward voltage	$V_F$	$V_{GE}=0V, I_F=30A$ $T_j=25^\circ\text{C}$ $T_j=150^\circ\text{C}$	-	1.55 1.55	2.05 2.05	
Gate-emitter threshold voltage	$V_{GE(th)}$	$I_C=700\mu A, V_{CE}=V_{GE}$	3	4	5	
Zero gate voltage collector current	$I_{CES}$	$V_{CE}=600V, V_{GE}=0V$ $T_j=25^\circ\text{C}$ $T_j=150^\circ\text{C}$	- -	- -	40 3000	$\mu A$
Gate-emitter leakage current	$I_{GES}$	$V_{CE}=0V, V_{GE}=20V$	-	-	100	
Transconductance	$g_{fs}$	$V_{CE}=20V, I_C=30A$	-	20		S

**Dynamic Characteristic**

Input capacitance	$C_{iss}$	$V_{CE}=25V,$ $V_{GE}=0V,$ $f=1\text{MHz}$	-	1500		pF
Output capacitance	$C_{oss}$		-	203		
Reverse transfer capacitance	$C_{riss}$		-	92		
Gate charge	$Q_{Gate}$	$V_{CC}=480V, I_C=30A$ $V_{GE}=15V$	-	141		nC
Internal emitter inductance measured 5mm (0.197 in.) from case	$L_E$		-	13		nH
Short circuit collector current <sup>1)</sup>	$I_{C(SC)}$	$V_{GE}=15V, t_{SC}\leq 10\mu s$ $V_{CC}\leq 600V,$ $T_j\leq 150^\circ\text{C}$	-	220		A

<sup>1)</sup> Allowed number of short circuits: <1000; time between short circuits: >1s.

### Switching Characteristic, Inductive Load, at $T_j=25^\circ\text{C}$

Parameter	Symbol	Conditions	Value			Unit
			min.	typ.	max.	
<b>IGBT Characteristic</b>						
Turn-on delay time	$t_{d(on)}$	$T_j=25^\circ\text{C}$ , $V_{CC}=400\text{V}$ , $I_C=30\text{A}$ , $V_{GE}=0/15\text{V}$ , $R_G=11\Omega$ $L_{\sigma}^{2)}=60\text{nH}$ , $C_{\sigma}^{2)}=40\text{pF}$ Energy losses include "tail" and diode reverse recovery.	-	20		ns
Rise time	$t_r$		-	21		
Turn-off delay time	$t_{d(off)}$		-	250		
Fall time	$t_f$		-	25		
Turn-on energy	$E_{on}$		-	0.60		mJ
Turn-off energy	$E_{off}$		-	0.55		
Total switching energy	$E_{ts}$		-	1.15		

### Anti-Parallel Diode Characteristic

Diode reverse recovery time	$t_{rr}$	$T_j=25^\circ\text{C}$ , $V_R=400\text{V}$ , $I_F=30\text{A}$ , $di_F/dt=1100\text{A}/\mu\text{s}$	-	125		ns
	$t_s$		-	20		
	$t_F$		-	105		
Diode reverse recovery charge	$Q_{rr}$		-	0.82		$\mu\text{C}$
Diode peak reverse recovery current	$I_{rrm}$		-	17		A
Diode peak rate of fall of reverse recovery current during $t_b$	$di_{rr}/dt$		-	580		$\text{A}/\mu\text{s}$

<sup>2)</sup> Leakage inductance  $L_{\sigma}$  and Stray capacity  $C_{\sigma}$  due to test circuit in Figure E.

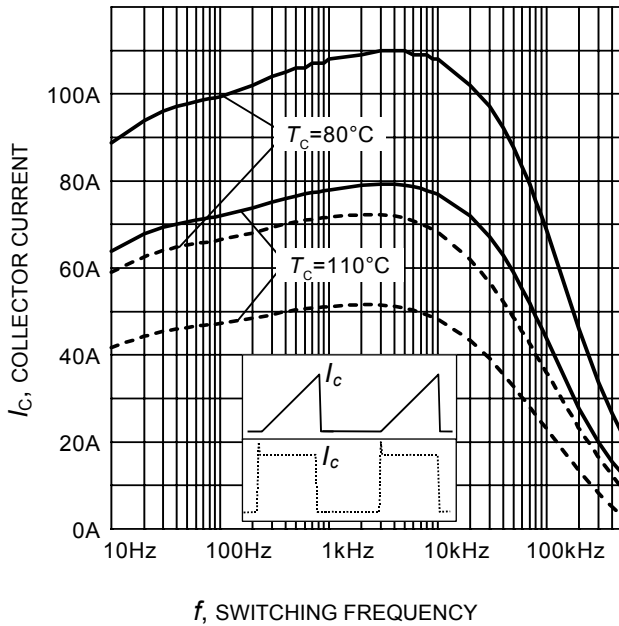
**Switching Characteristic, Inductive Load, at  $T_j=150^\circ\text{C}$** 

Parameter	Symbol	Conditions	Value			Unit
			min.	typ.	max.	
<b>IGBT Characteristic</b>						
Turn-on delay time	$t_{d(on)}$	$T_j=150^\circ\text{C}$ $V_{CC}=400\text{V}, I_C=30\text{A},$ $V_{GE}=0/15\text{V},$ $R_G=1.8\Omega$	-	16		ns
Rise time	$t_r$		-	13		
Turn-off delay time	$t_{d(off)}$		-	122		
Fall time	$t_f$		-	29		
Turn-on energy	$E_{on}$	$L_{\sigma}^{(1)}=60\text{nH},$ $C_{\sigma}^{(1)}=40\text{pF}$ Energy losses include "tail" and diode reverse recovery.	-	0.78		mJ
Turn-off energy	$E_{off}$		-	0.48		
Total switching energy	$E_{ts}$		-	1.26		
Turn-on delay time	$t_{d(on)}$	$T_j=150^\circ\text{C}$ $V_{CC}=400\text{V}, I_C=30\text{A},$ $V_{GE}=0/15\text{V},$ $R_G=11\Omega$	-	20		ns
Rise time	$t_r$		-	19		
Turn-off delay time	$t_{d(off)}$		-	274		
Fall time	$t_f$		-	27		
Turn-on energy	$E_{on}$	$L_{\sigma}^{(1)}=60\text{nH},$ $C_{\sigma}^{(1)}=40\text{pF}$ Energy losses include "tail" and diode reverse recovery.	-	0.91		mJ
Turn-off energy	$E_{off}$		-	0.70		
Total switching energy	$E_{ts}$		-	1.61		

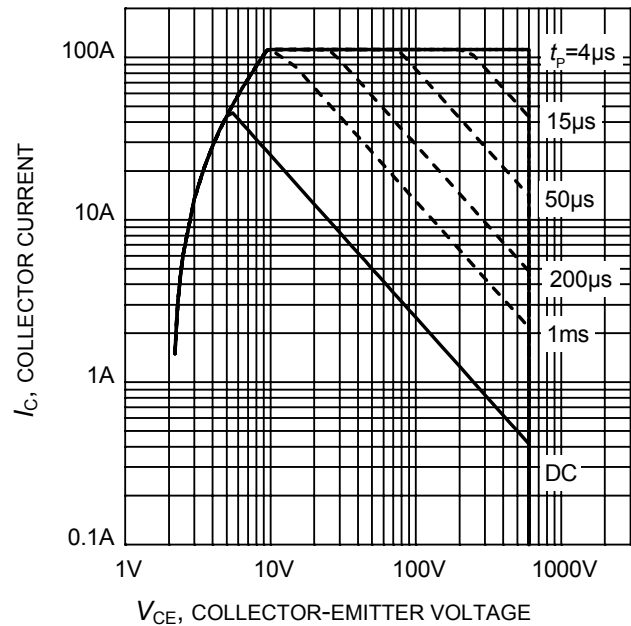
**Anti-Parallel Diode Characteristic**

Diode reverse recovery time	$t_{rr}$	$T_j=150^\circ\text{C}$ $V_R=400\text{V}, I_F=30\text{A},$ $di_F/dt=1250\text{A}/\mu\text{s}$	-	190		ns
	$t_s$		-	30		
	$t_F$		-	160		
Diode reverse recovery charge	$Q_{rr}$		-	2.0		$\mu\text{C}$
Diode peak reverse recovery current	$I_{rrm}$		-	24		A
Diode peak rate of fall of reverse recovery current during $t_b$	$di_{rr}/dt$		-	480		$\text{A}/\mu\text{s}$

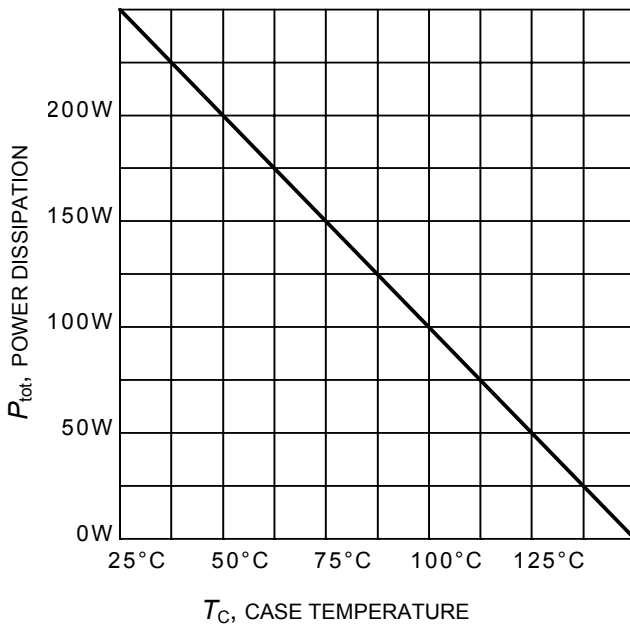
<sup>1)</sup> Leakage inductance  $L_{\sigma}$  and Stray capacity  $C_{\sigma}$  due to test circuit in Figure E.



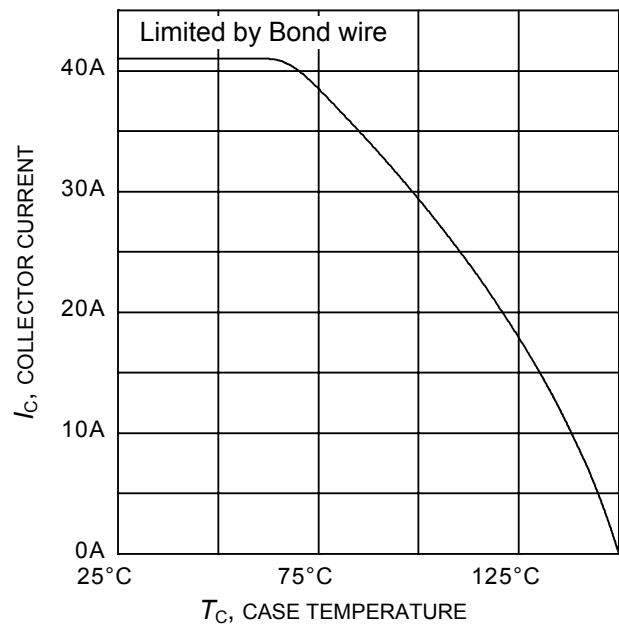
**Figure 1. Collector current as a function of switching frequency**  
 ( $T_j \leq 150^\circ\text{C}$ ,  $D = 0.5$ ,  $V_{CE} = 400\text{V}$ ,  $V_{GE} = 0/+15\text{V}$ ,  $R_G = 11\Omega$ )



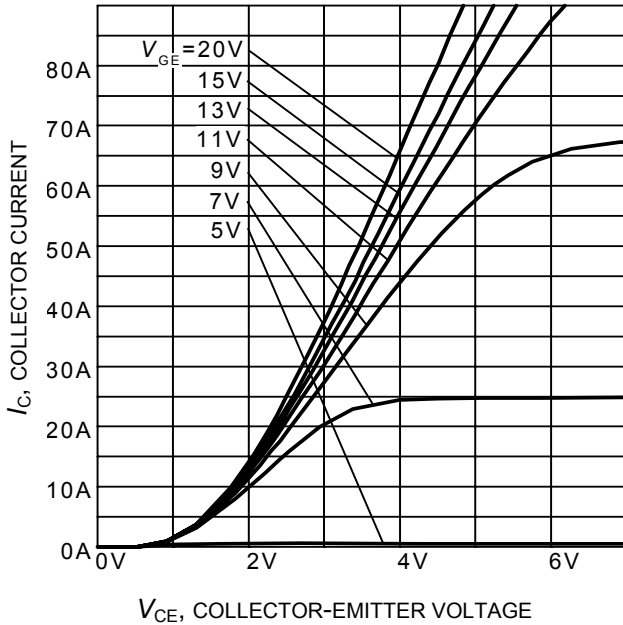
**Figure 2. Safe operating area**  
 ( $D = 0$ ,  $T_C = 25^\circ\text{C}$ ,  $T_j \leq 150^\circ\text{C}$ ;  $V_{GE} = 15\text{V}$ )



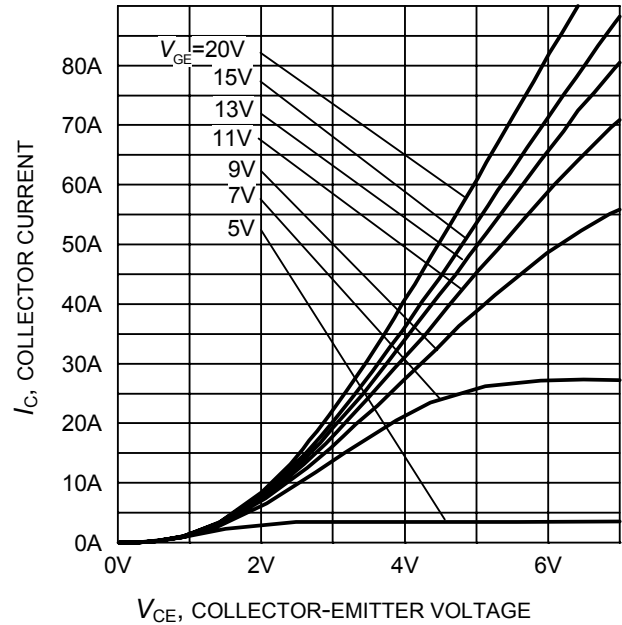
**Figure 3. Power dissipation as a function of case temperature**  
 ( $T_j \leq 150^\circ\text{C}$ )



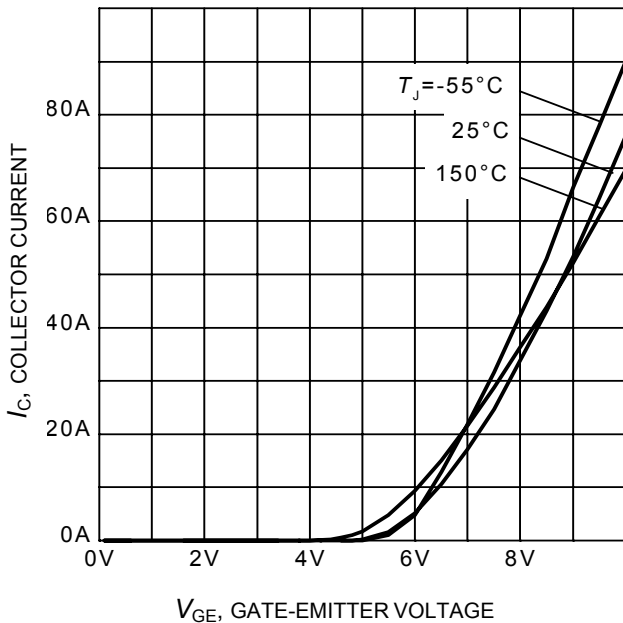
**Figure 4. Collector current as a function of case temperature**  
 ( $V_{GE} \leq 15\text{V}$ ,  $T_j \leq 150^\circ\text{C}$ )



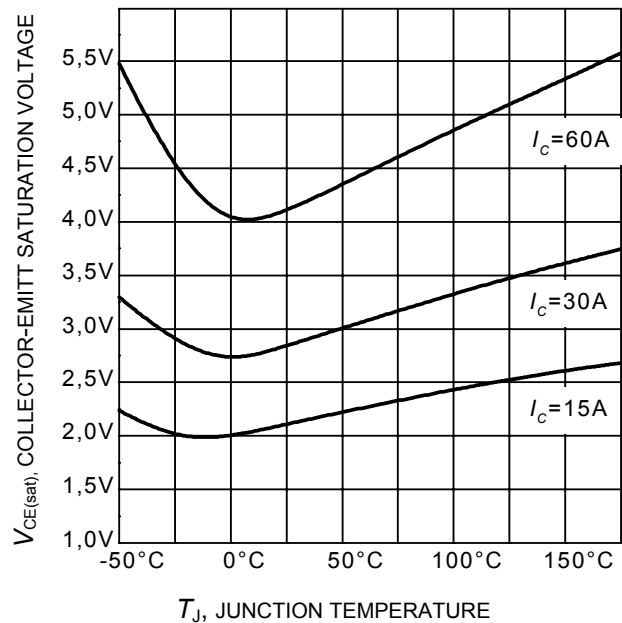
**Figure 5. Typical output characteristic**  
( $T_j = 25^\circ\text{C}$ )



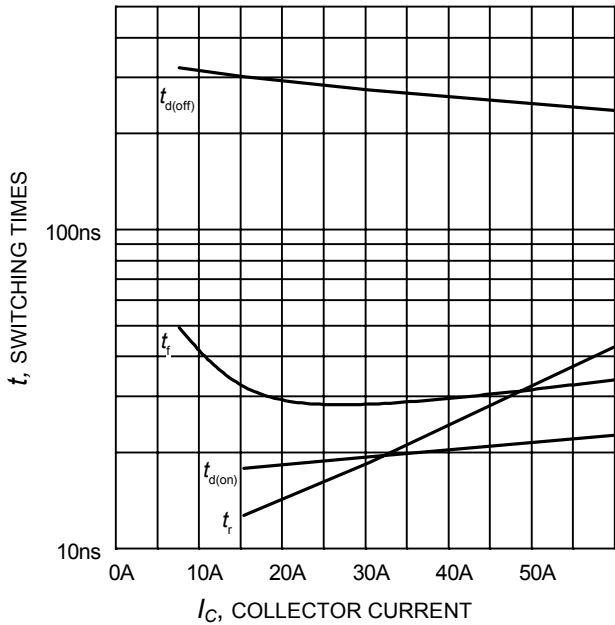
**Figure 6. Typical output characteristic**  
( $T_j = 150^\circ\text{C}$ )



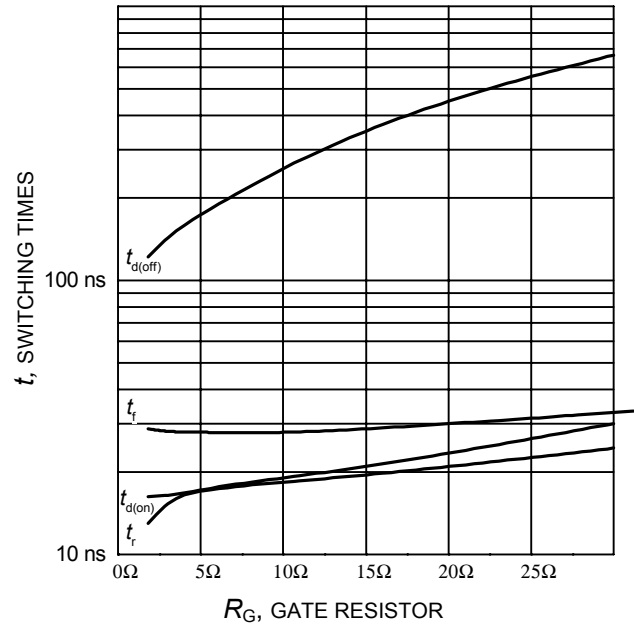
**Figure 7. Typical transfer characteristic**  
( $V_{CE} = 10\text{V}$ )



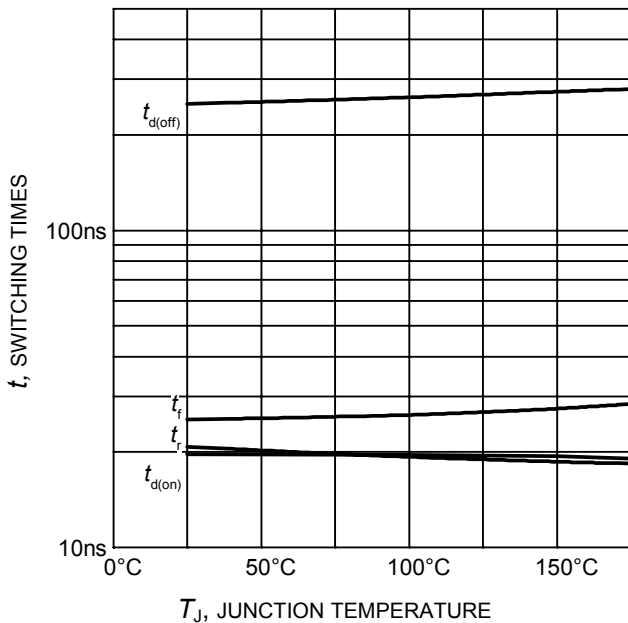
**Figure 8. Typical collector-emitter saturation voltage as a function of junction temperature**  
( $V_{GE} = 15\text{V}$ )



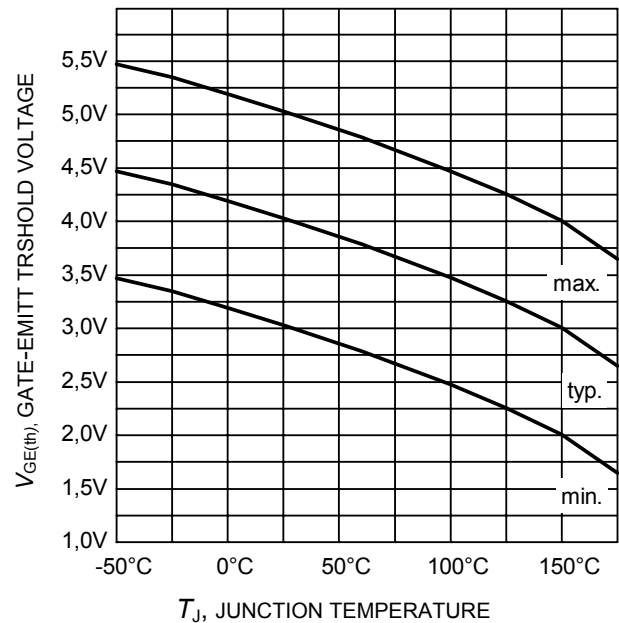
**Figure 9. Typical switching times as a function of collector current**  
 (inductive load,  $T_J=150^{\circ}\text{C}$ ,  $V_{CE}=400\text{V}$ ,  $V_{GE}=0/15\text{V}$ ,  $R_G=11\Omega$ , Dynamic test circuit in Figure E)



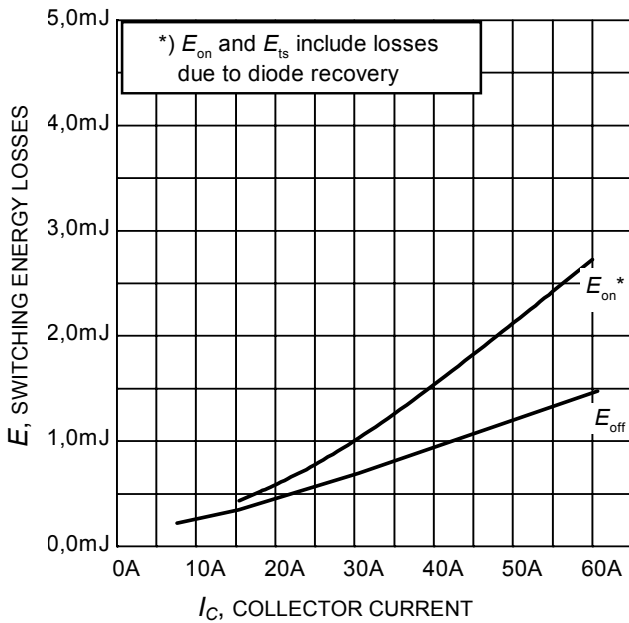
**Figure 10. Typical switching times as a function of gate resistor**  
 (inductive load,  $T_J=150^{\circ}\text{C}$ ,  $V_{CE}=400\text{V}$ ,  $V_{GE}=0/15\text{V}$ ,  $I_C=30\text{A}$ , Dynamic test circuit in Figure E)



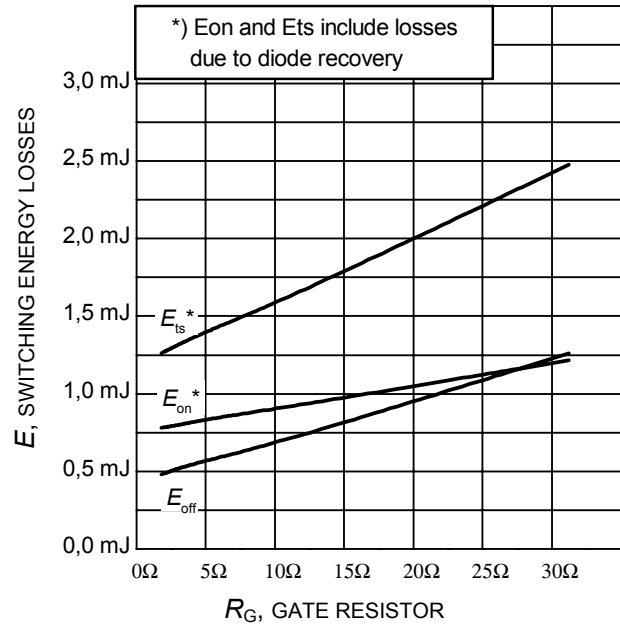
**Figure 11. Typical switching times as a function of junction temperature**  
 (inductive load,  $V_{CE}=400\text{V}$ ,  $V_{GE}=0/15\text{V}$ ,  $I_C=30\text{A}$ ,  $R_G=11\Omega$ , Dynamic test circuit in Figure E)



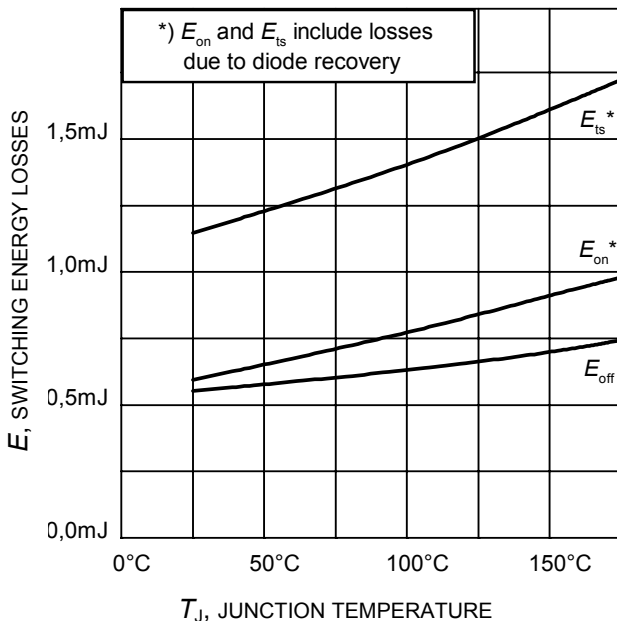
**Figure 12. Gate-emitter threshold voltage as a function of junction temperature**  
 ( $I_C = 0.7\text{mA}$ )



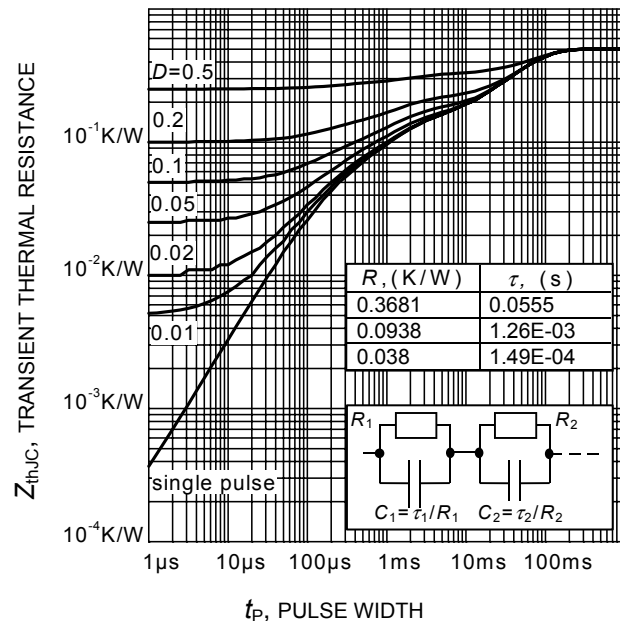
**Figure 13. Typical switching energy losses as a function of collector current**  
(inductive load,  $T_J=150^\circ\text{C}$ ,  $V_{CE}=400\text{V}$ ,  $V_{GE}=0/15\text{V}$ ,  $R_G=11\Omega$ , Dynamic test circuit in Figure E)



**Figure 14. Typical switching energy losses as a function of gate resistor**  
(inductive load,  $T_J=150^\circ\text{C}$ ,  $V_{CE}=400\text{V}$ ,  $V_{GE}=0/15\text{V}$ ,  $I_C=30\text{A}$ , Dynamic test circuit in Figure E)

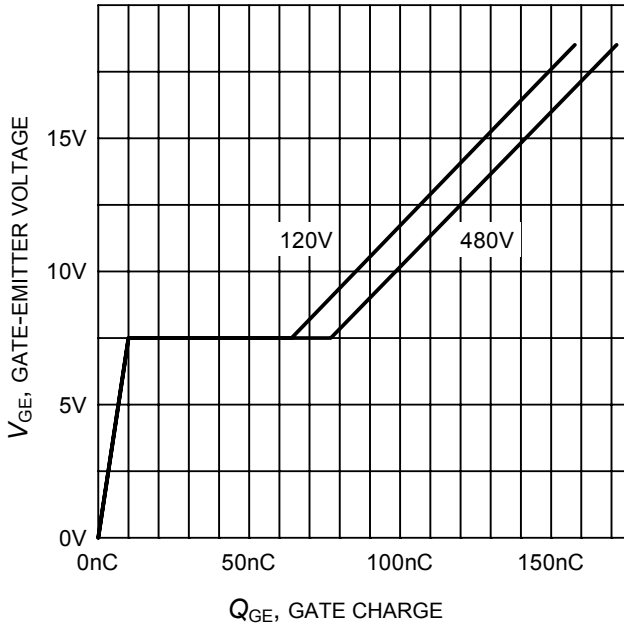


**Figure 15. Typical switching energy losses as a function of junction temperature**  
(inductive load,  $V_{CE}=400\text{V}$ ,  $V_{GE}=0/15\text{V}$ ,  $I_C=30\text{A}$ ,  $R_G=11\Omega$ , Dynamic test circuit in Figure E)

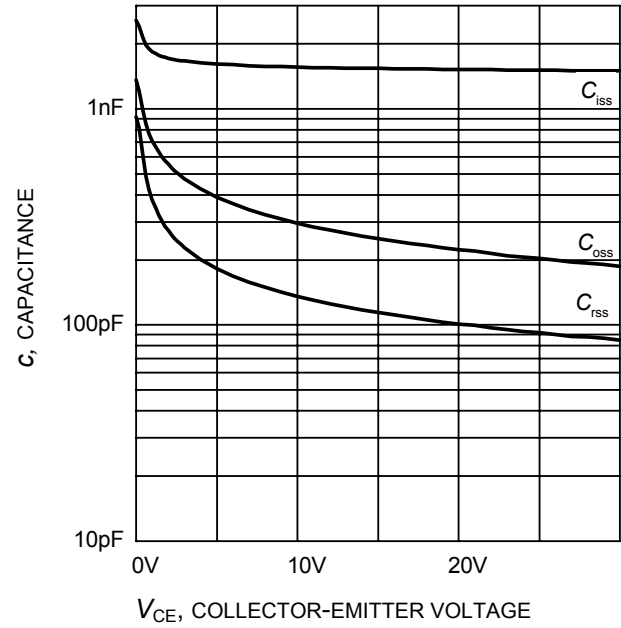


**Figure 16. IGBT transient thermal resistance**  
( $D = t_p / T$ )

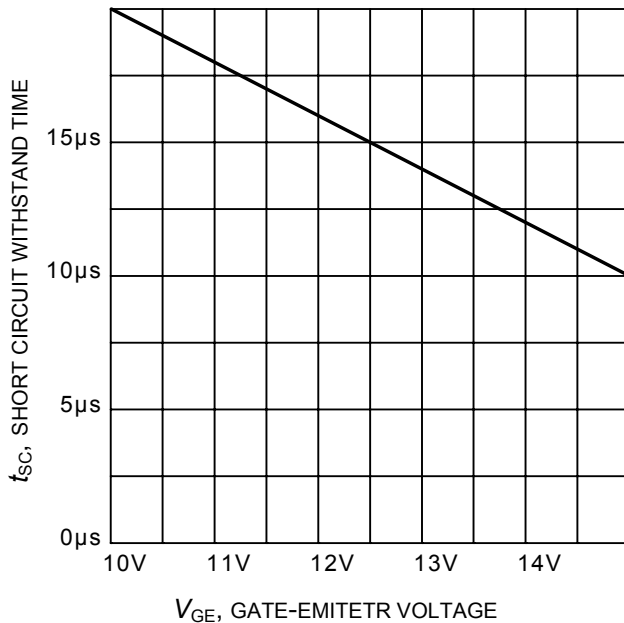




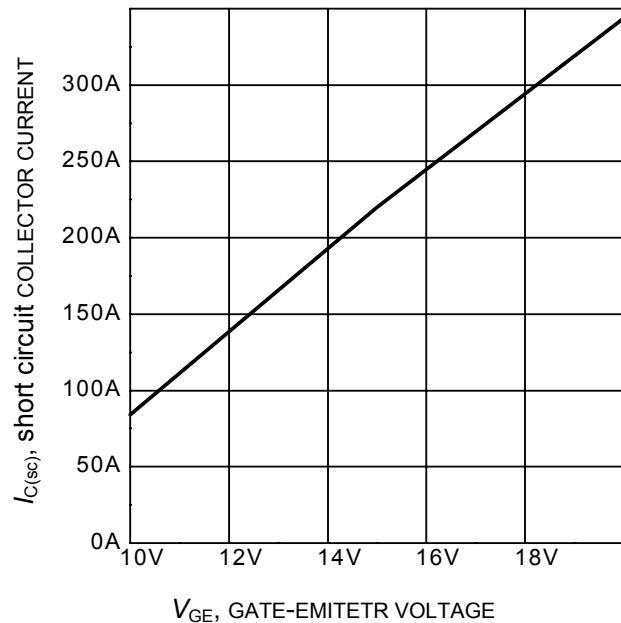
**Figure 17. Typical gate charge**  
( $I_C=30\text{ A}$ )



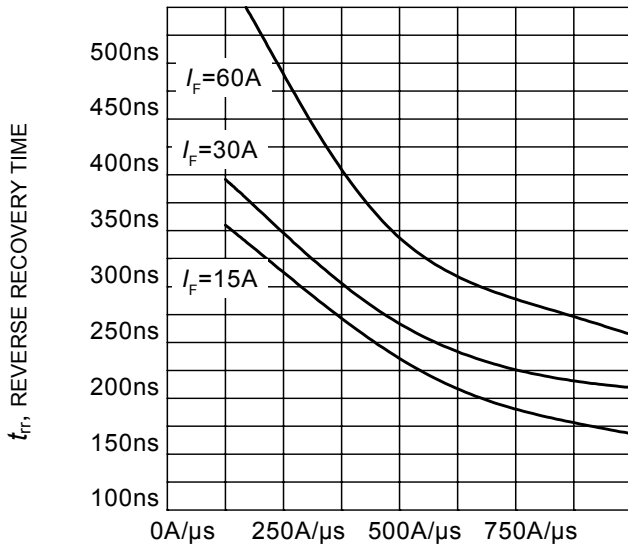
**Figure 18. Typical capacitance as a function of collector-emitter voltage**  
( $V_{GE}=0\text{V}$ ,  $f = 1\text{ MHz}$ )



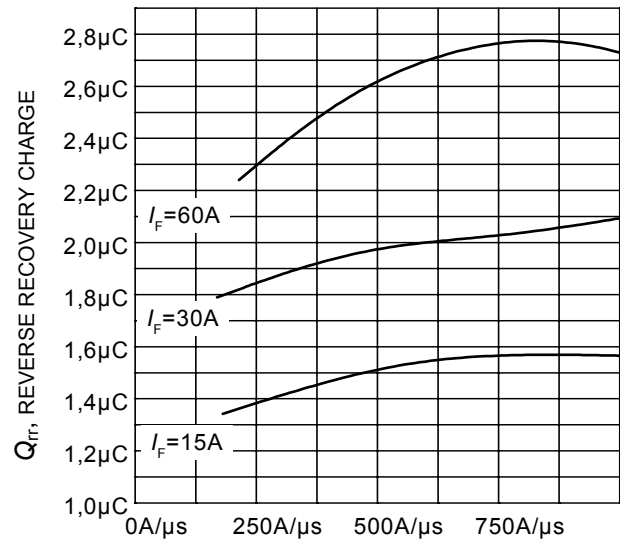
**Figure 19. Short circuit withstand time as a function of gate-emitter voltage**  
( $V_{CE}=600\text{V}$ , start at  $T_J=25^\circ\text{C}$ )



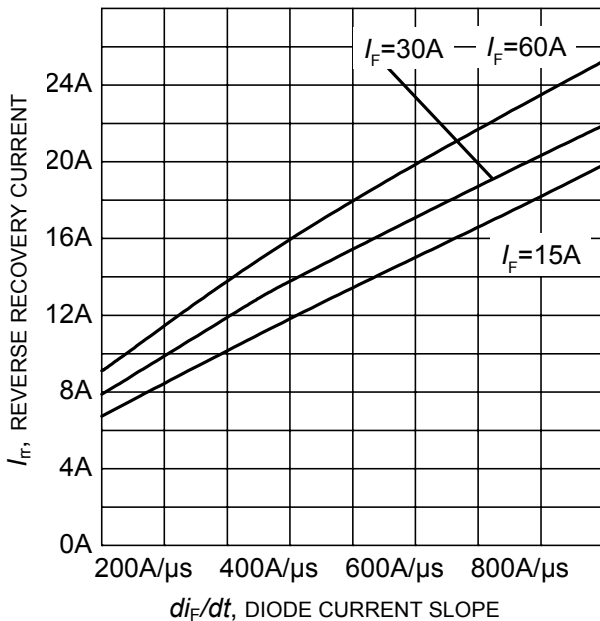
**Figure 20. Typical short circuit collector current as a function of gate-emitter voltage**  
( $V_{CE} \leq 600\text{V}$ ,  $T_J \leq 150^\circ\text{C}$ )



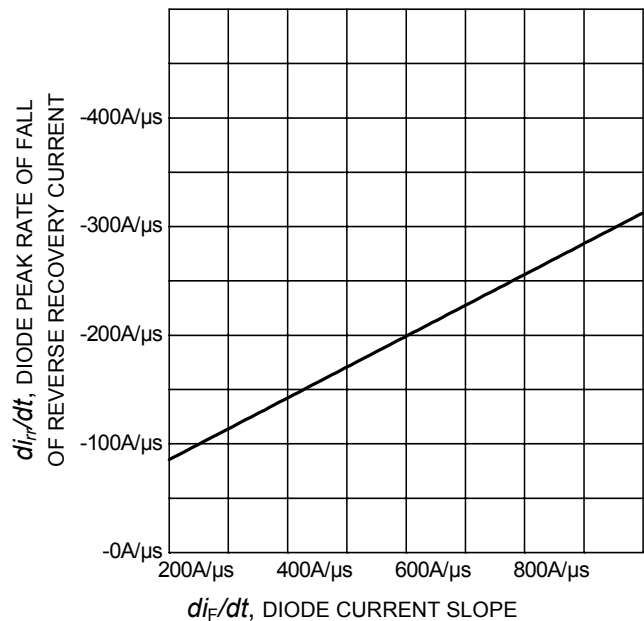
$di_F/dt$ , DIODE CURRENT SLOPE  
**Figure 21. Typical reverse recovery time as a function of diode current slope**  
 ( $V_R=400V$ ,  $T_J=150^\circ C$ ,  
 Dynamic test circuit in Figure E)



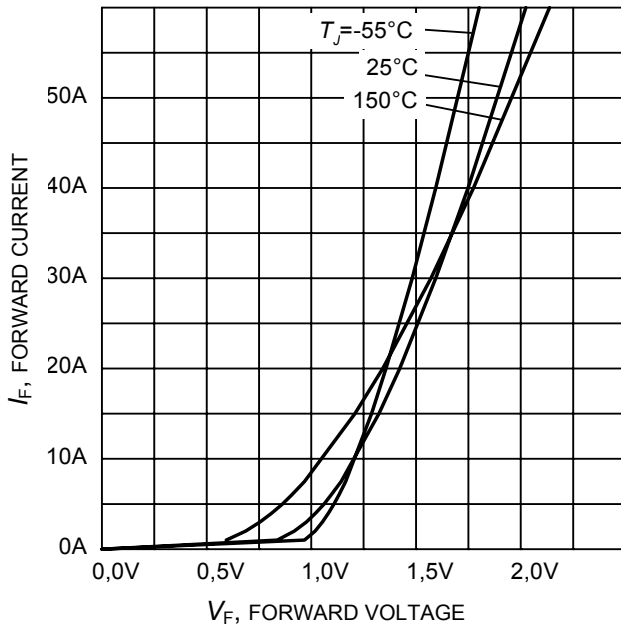
$di_F/dt$ , DIODE CURRENT SLOPE  
**Figure 22. Typical reverse recovery charge as a function of diode current slope**  
 ( $V_R=400V$ ,  $T_J=150^\circ C$ ,  
 Dynamic test circuit in Figure E)



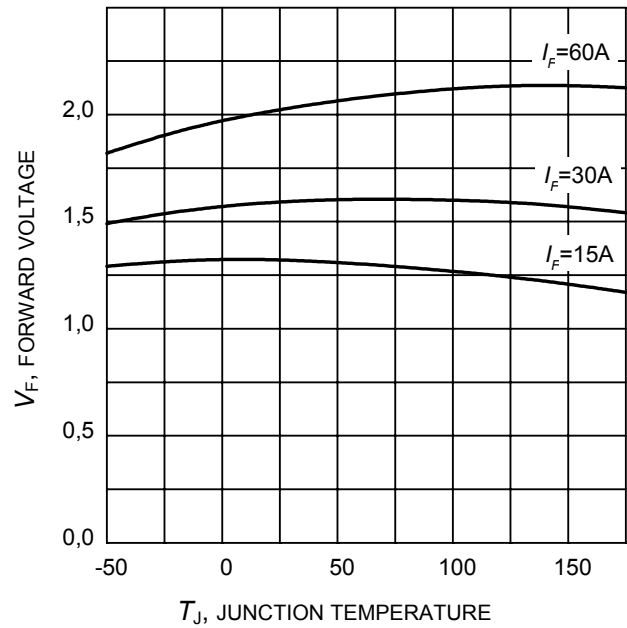
$di_F/dt$ , DIODE CURRENT SLOPE  
**Figure 23. Typical reverse recovery current as a function of diode current slope**  
 ( $V_R=400V$ ,  $T_J=150^\circ C$ ,  
 Dynamic test circuit in Figure E)



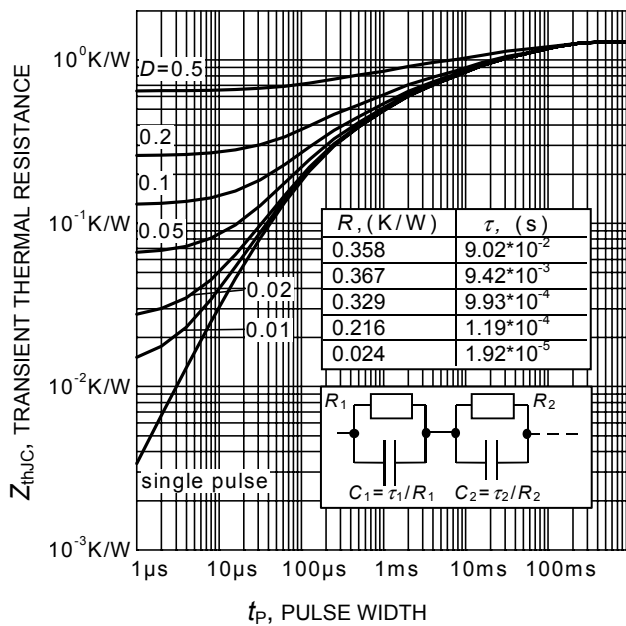
$di_F/dt$ , DIODE CURRENT SLOPE  
**Figure 24. Typical diode peak rate of fall of reverse recovery current as a function of diode current slope**  
 ( $V_R=400V$ ,  $T_J=150^\circ C$ ,  
 Dynamic test circuit in Figure E)



**Figure 25. Typical diode forward current as a function of forward voltage**

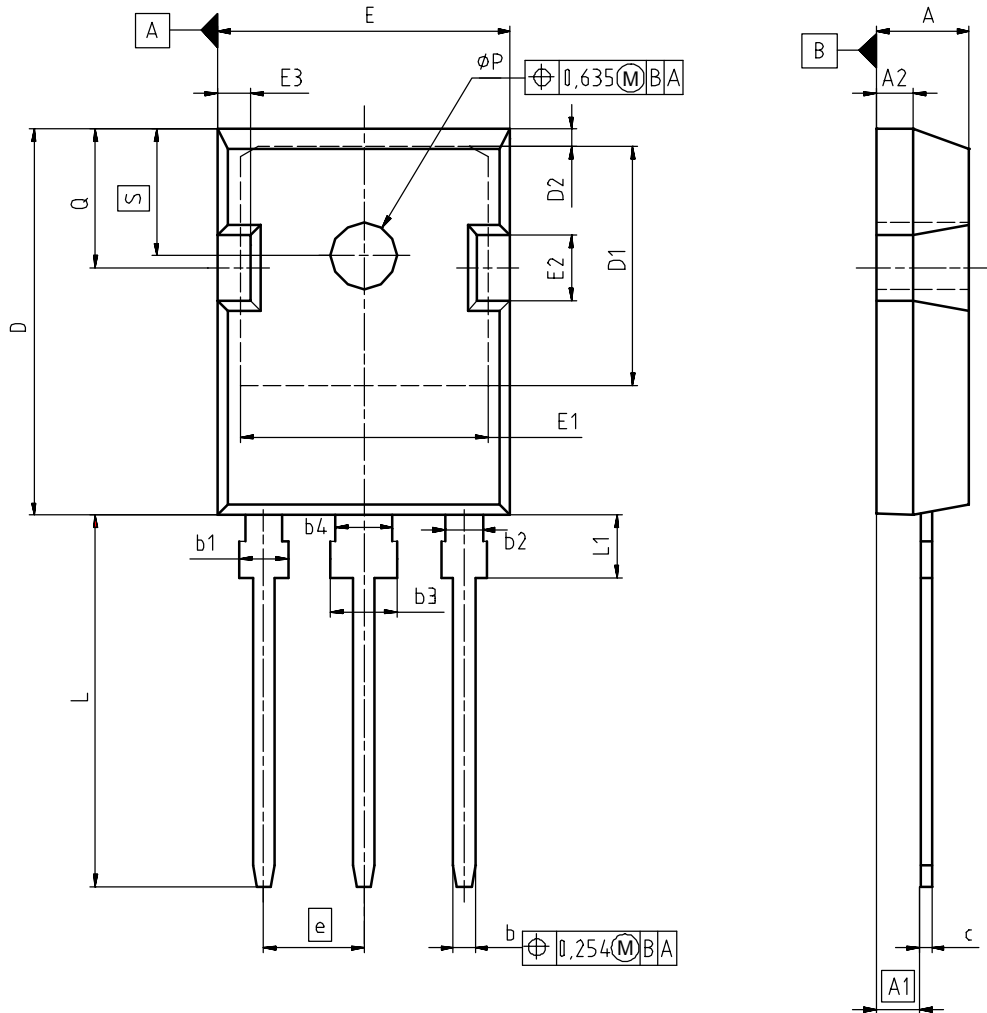


**Figure 26. Typical diode forward voltage as a function of junction temperature**



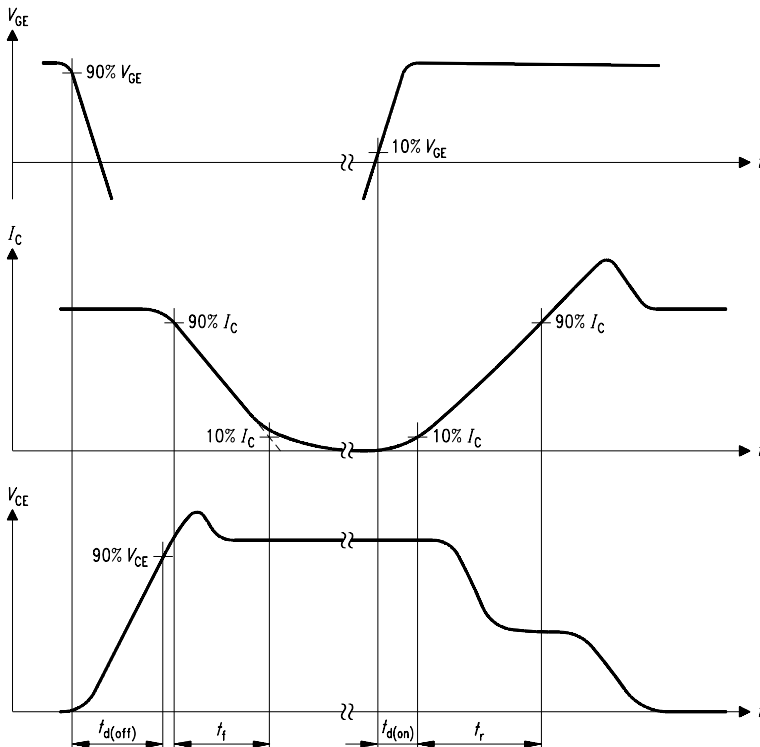
**Figure 27. Diode transient thermal impedance as a function of pulse width ( $D = t_p / T$ )**

## PG-TO247-3



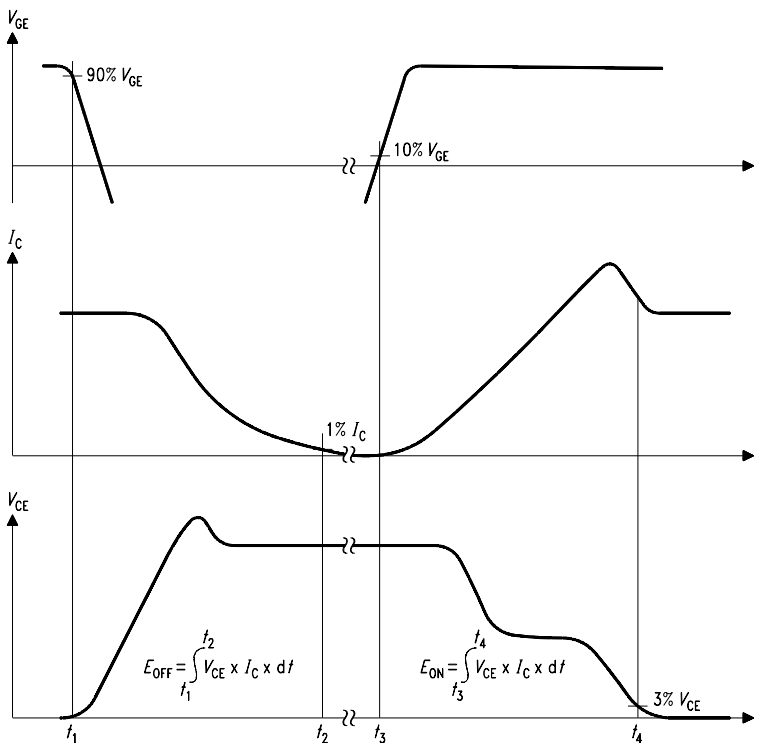
DIM	MILLIMETERS		INCHES	
	MIN	MAX	MIN	MAX
A	4.90	5.16	0.193	0.203
A1	2.27	2.53	0.089	0.099
A2	1.85	2.11	0.073	0.083
b	1.07	1.33	0.042	0.052
b1	1.90	2.41	0.075	0.095
b2	1.90	2.16	0.075	0.085
b3	2.87	3.38	0.113	0.133
b4	2.87	3.13	0.113	0.123
c	0.55	0.68	0.022	0.027
D	20.82	21.10	0.820	0.831
D1	16.25	17.65	0.640	0.695
D2	1.05	1.35	0.041	0.053
E	15.70	16.03	0.618	0.631
E1	13.10	14.15	0.516	0.557
E2	3.68	5.10	0.145	0.201
E3	1.68	2.60	0.066	0.102
e	5.44		0.214	
N	3		3	
L	19.80	20.31	0.780	0.799
L1	4.17	4.47	0.164	0.176
øP	3.50	3.70	0.138	0.146
Q	5.49	6.00	0.216	0.236
S	6.04	6.30	0.238	0.248

DOCUMENT NO. Z8B00003327
SCALE 0 5 5 7.5mm
EUROPEAN PROJECTION 
ISSUE DATE 17-12-2007
REVISION 03



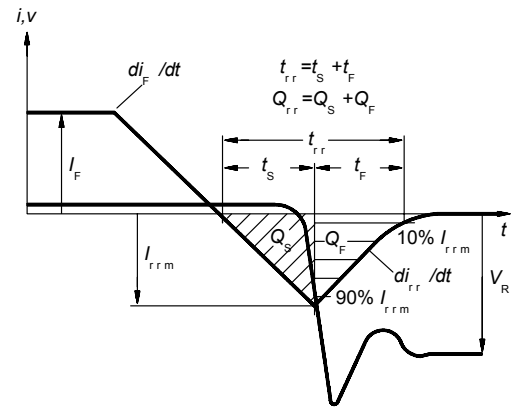
**Figure A. Definition of switching times**

SIS00053

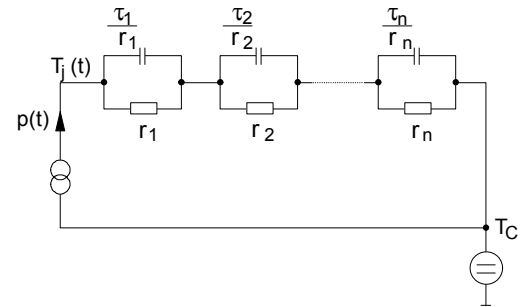


**Figure B. Definition of switching losses**

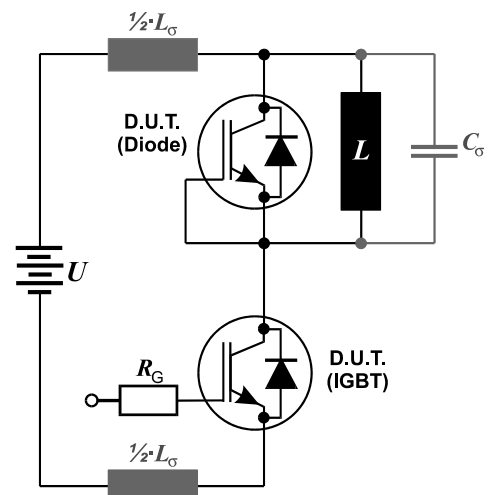
SIS00050



**Figure C. Definition of diodes switching characteristics**



**Figure D. Thermal equivalent circuit**



**Figure E. Dynamic test circuit**  
Leakage inductance  $L_{\sigma} = 60\text{nH}$   
and Stray capacity  $C_{\sigma} = 40\text{pF}$ .

**Published by**  
**Infineon Technologies AG**  
**81726 Munich, Germany**  
**© 2008 Infineon Technologies AG**  
**All Rights Reserved.**

### **Legal Disclaimer**

The information given in this document shall in no event be regarded as a guarantee of conditions or characteristics. With respect to any examples or hints given herein, any typical values stated herein and/or any information regarding the application of the device, Infineon Technologies hereby disclaims any and all warranties and liabilities of any kind, including without limitation, warranties of non-infringement of intellectual property rights of any third party.

### **Information**

For further information on technology, delivery terms and conditions and prices, please contact the nearest Infineon Technologies Office ([www.infineon.com](http://www.infineon.com)).

### **Warnings**

Due to technical requirements, components may contain dangerous substances. For information on the types in question, please contact the nearest Infineon Technologies Office. Infineon Technologies components may be used in life-support devices or systems only with the express written approval of Infineon Technologies, if a failure of such components can reasonably be expected to cause the failure of that life-support device or system or to affect the safety or effectiveness of that device or system. Life support devices or systems are intended to be implanted in the human body or to support and/or maintain and sustain and/or protect human life. If they fail, it is reasonable to assume that the health of the user or other persons may be endangered.