

SKM 400GB125D

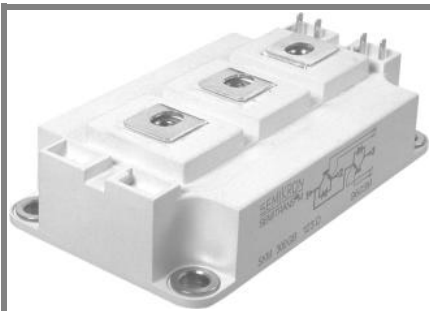

SEMITRANS® 3

Ultra Fast IGBT Modules

SKM 400GB125D

SKM 400GAL125D

SKM 400GAR125D

Features

- Low inductance case
- Short tail current with low temperature dependence
- High short circuit capability, self limiting to $6 \times I_{Cnom}$
- Fast & soft inverse CAL diodes
- Isolated copper baseplate using DBC Direct Copper Bonding Technology
- Large clearance (13 mm) and creepage distances (20 mm)

Typical Applications*

- Switched mode power supplies at $f_{sw} > 20\text{kHz}$
- Resonant inverters up to 100 kHz
- Inductive heating
- Electronic welders at $f_{sw} > 20\text{kHz}$

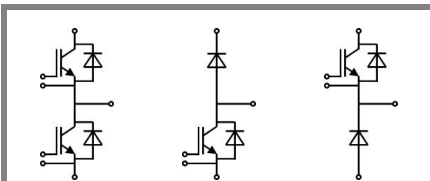

GB

GAL

GAR

Absolute Maximum Ratings		$T_c = 25^\circ\text{C}$, unless otherwise specified		
Symbol	Conditions	Values		Units
IGBT				
V_{CES}	$T_j = 25^\circ\text{C}$	1200		V
I_C	$T_j = 150^\circ\text{C}$	$T_{case} = 25^\circ\text{C}$	400	A
		$T_{case} = 80^\circ\text{C}$	300	A
I_{CRM}	$I_{CRM} = 2 \times I_{Cnom}$	600		A
V_{GES}		± 20		V
t_{psc}	$V_{CC} = 600\text{V}; V_{GE} \leq 20\text{V}; T_j = 125^\circ\text{C}$ $V_{CES} < 1200\text{V}$	10		μs
Inverse Diode				
I_F	$T_j = 150^\circ\text{C}$	$T_{case} = 25^\circ\text{C}$	390	A
		$T_{case} = 80^\circ\text{C}$	260	A
I_{FRM}	$I_{FRM} = 2 \times I_{Fnom}$	600		A
I_{FSM}	$t_p = 10\text{ms}; \text{sin.}$	$T_j = 150^\circ\text{C}$	2880	
Freewheeling Diode				
I_F	$T_j = 150^\circ\text{C}$	$T_{case} = 25^\circ\text{C}$	390	A
		$T_{case} = 80^\circ\text{C}$	260	A
I_{FRM}	$I_{FRM} = 2 \times I_{Fnom}$	600		A
I_{FSM}	$t_p = 10\text{ms}; \text{sin.}$	$T_j = 150^\circ\text{C}$	2880	
Module				
$I_{t(RMS)}$		500		A
T_{vj}		- 40...+ 150		$^\circ\text{C}$
T_{stg}		- 40...+ 125		$^\circ\text{C}$
V_{isol}	AC, 1 min.	4000		V

Characteristics		$T_c = 25^\circ\text{C}$, unless otherwise specified			
Symbol	Conditions	min.	typ.	max.	Units
IGBT					
$V_{GE(th)}$	$V_{GE} = V_{CE}, I_C = 12\text{mA}$	4,5	5,5	6,5	V
I_{CES}	$V_{GE} = 0\text{V}, V_{CE} = V_{CES}$		0,15	0,45	mA
V_{CE0}		$T_j = 25^\circ\text{C}$	1,4		V
		$T_j = 125^\circ\text{C}$	1,7		V
r_{CE}	$V_{GE} = 15\text{V}$	$T_j = 25^\circ\text{C}$	6,3		$\text{m}\Omega$
		$T_j = 125^\circ\text{C}$	7,6		$\text{m}\Omega$
$V_{CE(sat)}$	$I_{Cnom} = 300\text{A}, V_{GE} = 15\text{V}$	$T_j = 25^\circ\text{C}_{chiplev.}$	3,3	3,85	V
		$T_j = 125^\circ\text{C}_{chiplev.}$	4	4,55	V
C_{ies}	$V_{CE} = 25, V_{GE} = 0\text{V}$	$f = 1\text{MHz}$	22		nF
C_{oes}			3,3		nF
C_{res}			1,2		nF
Q_G	$V_{GE} = 0\text{V} - +20\text{V}$	2650		nC	
R_{Gint}	$T_j = ^\circ\text{C}$	1,25		Ω	
$t_{d(on)}$	$R_{Gon} = 2\Omega$	$V_{CC} = 600\text{V}$ $I_C = 300\text{A}$	70		ns
t_r			50		ns
E_{on}	$R_{Goff} = 2\Omega$	$T_j = 125^\circ\text{C}$ $V_{GE} = \pm 15\text{V}$	17		mJ
$t_{d(off)}$			500		ns
t_f			32		ns
E_{off}	per IGBT		18		mJ
$R_{th(j-c)}$			0,05		K/W

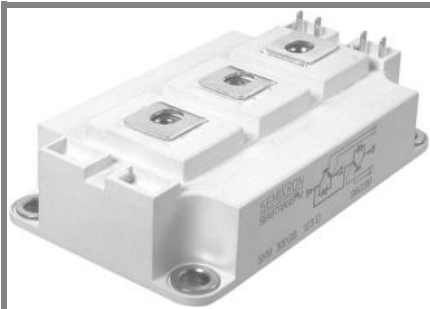

SEMITRANS® 3

Ultra Fast IGBT Modules

SKM 400GB125D

SKM 400GAL125D

SKM 400GAR125D

Features

- Low inductance case
- Short tail current with low temperature dependence
- High short circuit capability, self limiting to $6 \times I_{cnom}$
- Fast & soft inverse CAL diodes
- Isolated copper baseplate using DBC Direct Copper Bonding Technology
- Large clearance (13 mm) and creepage distances (20 mm)

Typical Applications*

- Switched mode power supplies at $f_{sw} > 20\text{kHz}$
- Resonant inverters up to 100 kHz
- Inductive heating
- Electronic welders at $f_{sw} > 20\text{kHz}$

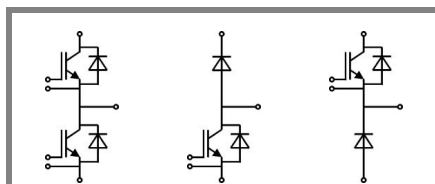

GB

GAL

GAR

Characteristics					
Symbol	Conditions	min.	typ.	max.	Units
Inverse Diode					
$V_F = V_{EC}$	$I_{Fnom} = 300\text{ A}; V_{GE} = 0\text{ V}$	$T_j = 25\text{ }^\circ\text{C}_{chiplev.}$	2	2,5	V
		$T_j = 125\text{ }^\circ\text{C}_{chiplev.}$	1,8		V
V_{F0}		$T_j = 25\text{ }^\circ\text{C}$	1,1	1,2	V
		$T_j = 125\text{ }^\circ\text{C}$			V
r_F		$T_j = 25\text{ }^\circ\text{C}$	3	4,3	mΩ
		$T_j = 125\text{ }^\circ\text{C}$			mΩ
I_{RRM}	$I_F = 300\text{ A}$	$T_j = 125\text{ }^\circ\text{C}$	350		A
Q_{rr}	$di/dt = 8300\text{ A}/\mu\text{s}$		45		μC
E_{rr}	$V_{GE} = 0\text{ V}; V_{CC} = 600\text{ V}$		16		mJ
$R_{th(j-c)D}$	per diode			0,125	K/W
Freewheeling Diode					
$V_F = V_{EC}$	$I_{Fnom} = 300\text{ A}; V_{GE} = 0\text{ V}$	$T_j = 25\text{ }^\circ\text{C}_{chiplev.}$	2	2,5	V
		$T_j = 125\text{ }^\circ\text{C}_{chiplev.}$	1,8		V
V_{F0}		$T_j = 25\text{ }^\circ\text{C}$	1,1	1,2	V
		$T_j = 125\text{ }^\circ\text{C}$			V
r_F		$T_j = 25\text{ }^\circ\text{C}$	3	4,3	V
		$T_j = 125\text{ }^\circ\text{C}$			V
I_{RRM}	$I_F = 300\text{ A}$	$T_j = 125\text{ }^\circ\text{C}$	350		A
Q_{rr}	$di/dt = 8300\text{ A}/\mu\text{s}$		45		μC
E_{rr}	$V_{GE} = 0\text{ V}; V_{CC} = 600\text{ V}$		16		mJ
$R_{th(j-c)FD}$	per diode			0,125	K/W
Module					
L_{CE}			15	20	nH
$R_{CC'+EE'}$	res., terminal-chip	$T_{case} = 25\text{ }^\circ\text{C}$	0,35		mΩ
		$T_{case} = 125\text{ }^\circ\text{C}$	0,5		mΩ
$R_{th(c-s)}$	per module			0,038	K/W
M_s	to heat sink M6		3	5	Nm
M_t	to terminals M6		2,5	5	Nm
w				325	g

This is an electrostatic discharge sensitive device (ESDS), international standard IEC 60747-1, Chapter IX.

* The specifications of our components may not be considered as an assurance of component characteristics. Components have to be tested for the respective application. Adjustments may be necessary. The use of SEMIKRON products in life support appliances and systems is subject to prior specification and written approval by SEMIKRON. We therefore strongly recommend prior consultation of our personal.

SKM 400GB125D

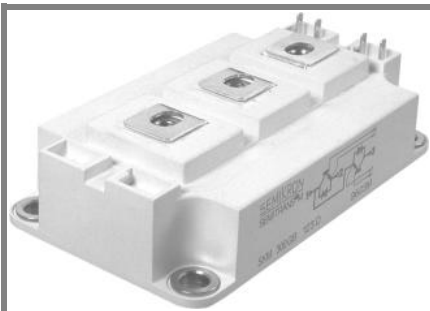

SEMITRANS® 3

Ultra Fast IGBT Modules

SKM 400GB125D

SKM 400GAL125D

SKM 400GAR125D

Features

- Low inductance case
- Short tail current with low temperature dependence
- High short circuit capability, self limiting to $6 \times I_{cnom}$
- Fast & soft inverse CAL diodes
- Isolated copper baseplate using DBC Direct Copper Bonding Technology
- Large clearance (13 mm) and creepage distances (20 mm)

Typical Applications*

- Switched mode power supplies at $f_{sw} > 20\text{kHz}$
- Resonant inverters up to 100 kHz
- Inductive heating
- Electronic welders at $f_{sw} > 20\text{ kHz}$

Z_{th}		Conditions	Values	Units
Symbol				
$Z_{th(j-c)I}$				
$R_{\theta j-c}$	$i = 1$		36	mk/W
$R_{\theta j-c}$	$i = 2$		10,5	mk/W
$R_{\theta j-c}$	$i = 3$		3	mk/W
$R_{\theta j-c}$	$i = 4$		0,5	mk/W
$\tau_{th(j-c)}$	$i = 1$		0,0744	s
$\tau_{th(j-c)}$	$i = 2$		0,0078	s
$\tau_{th(j-c)}$	$i = 3$		0,0016	s
$\tau_{th(j-c)}$	$i = 4$		0,0002	s
$Z_{th(j-c)D}$				
$R_{\theta j-c}$	$i = 1$		75	mk/W
$R_{\theta j-c}$	$i = 2$		38	mk/W
$R_{\theta j-c}$	$i = 3$		10,6	mk/W
$R_{\theta j-c}$	$i = 4$		1,4	mk/W
$\tau_{th(j-c)}$	$i = 1$		0,0386	s
$\tau_{th(j-c)}$	$i = 2$		0,0201	s
$\tau_{th(j-c)}$	$i = 3$		0,001	s
$\tau_{th(j-c)}$	$i = 4$		0,003	s

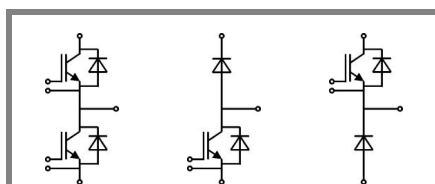

GB

GAL

GAR

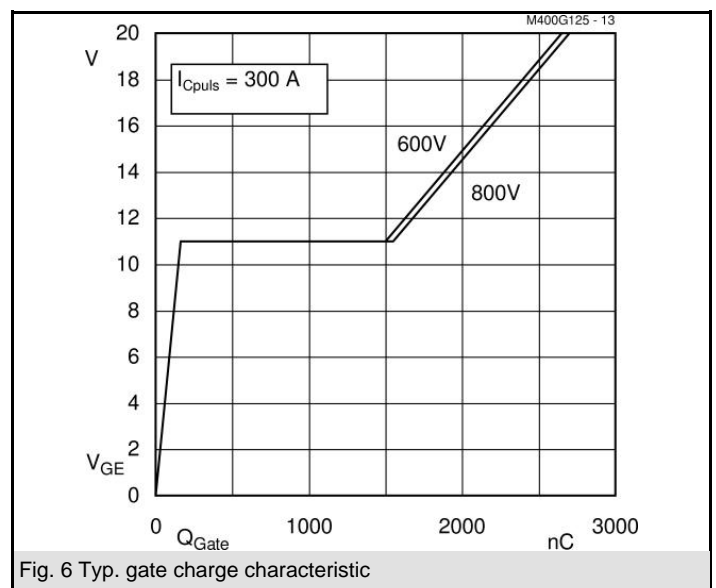
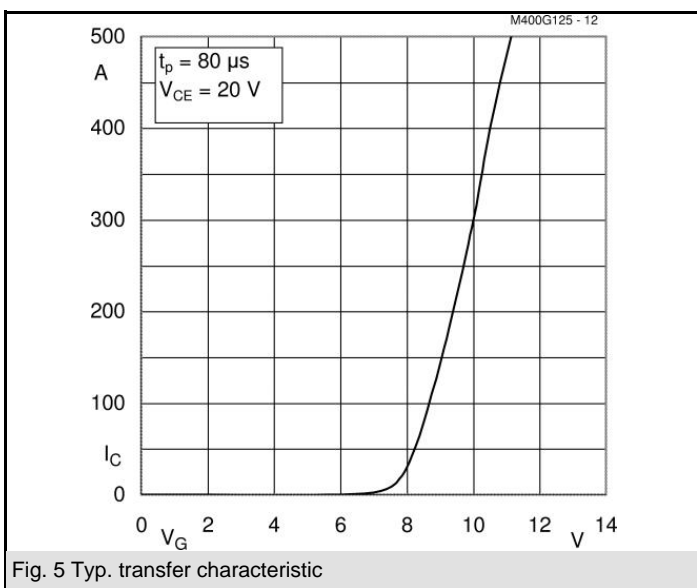
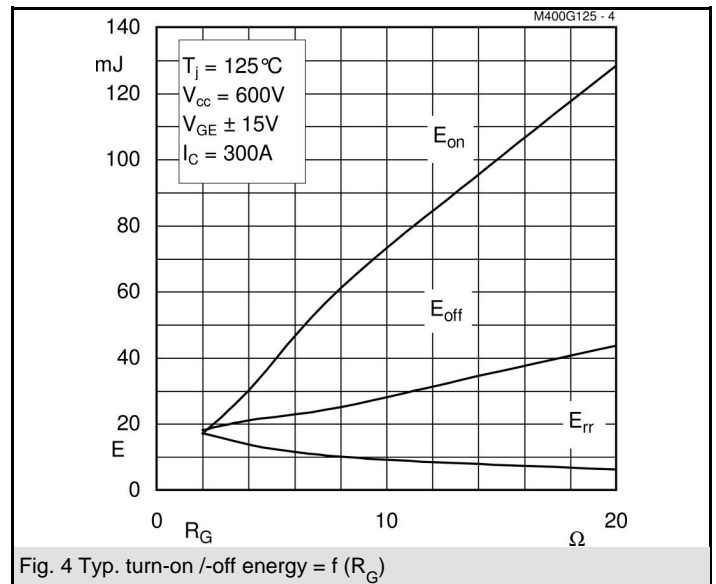
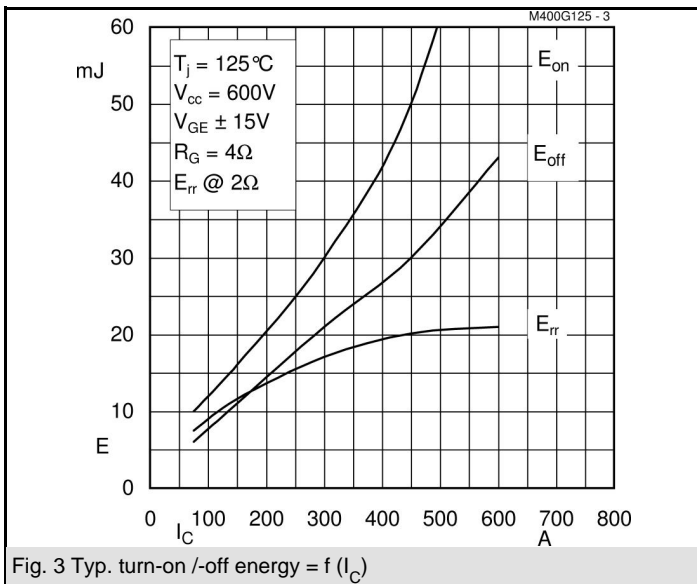
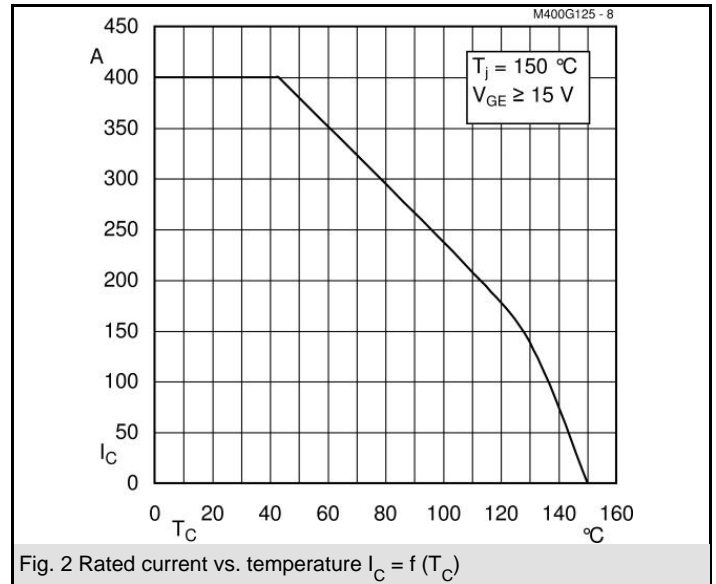
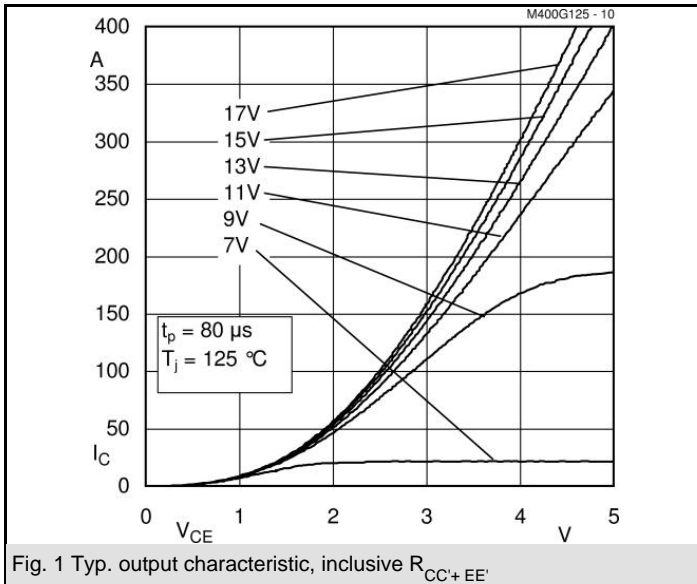

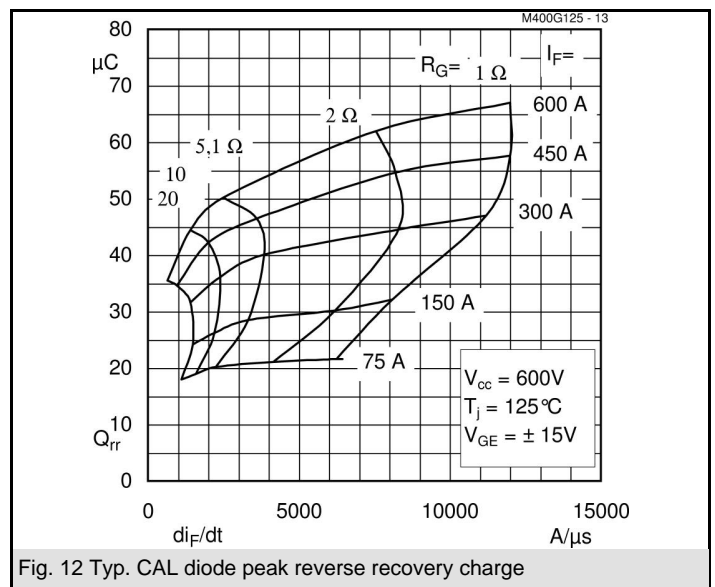
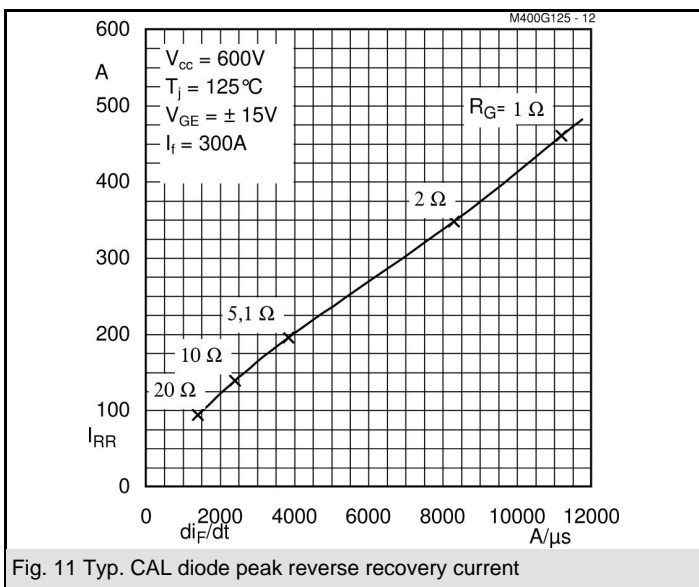
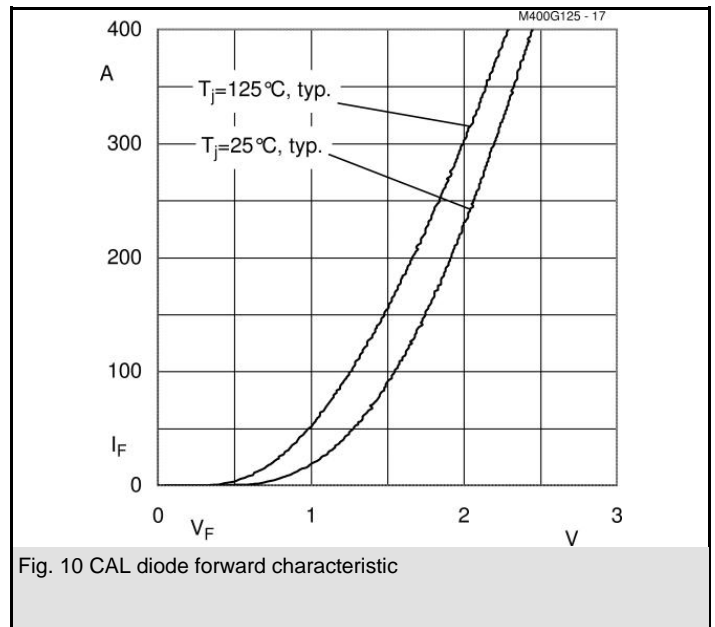
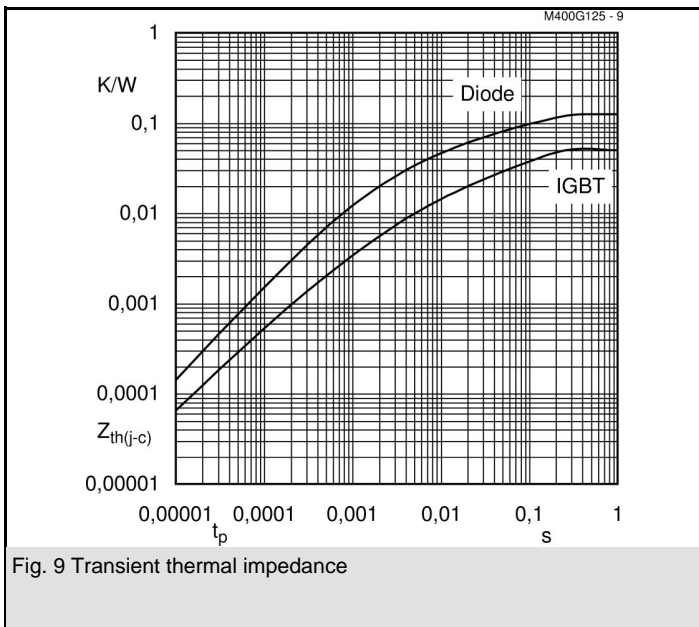
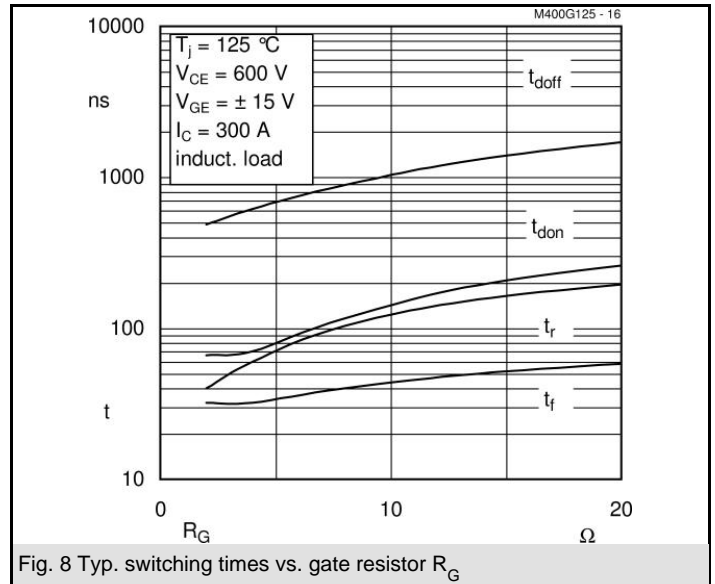
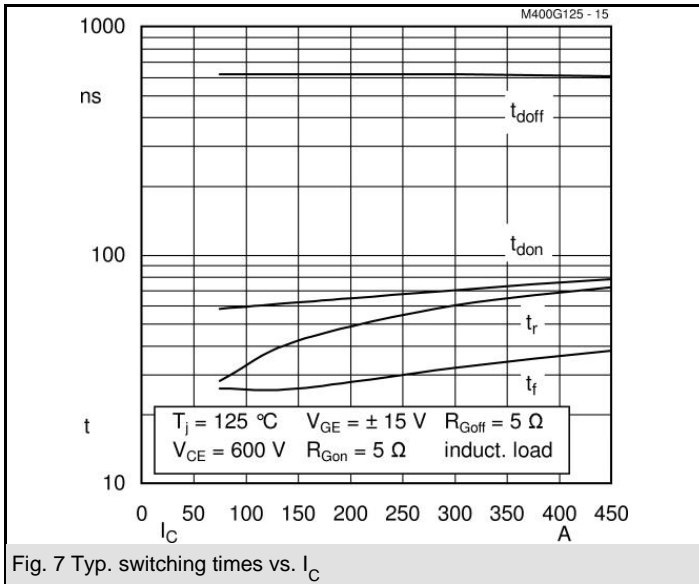

SKM 400GB125D

UL Recognized

CASED56

File 63 532

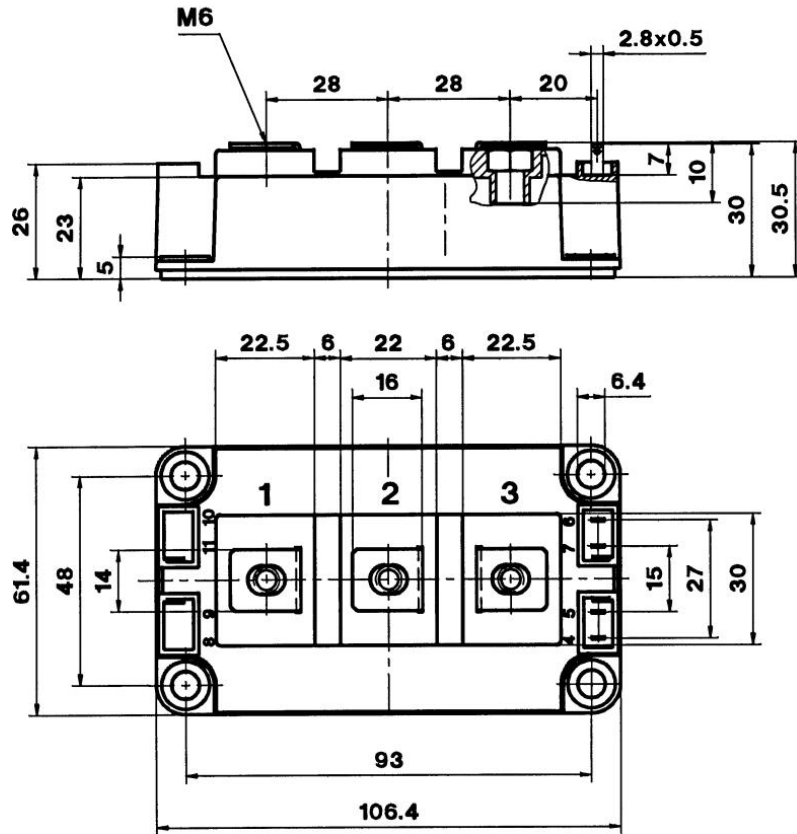

Case D 56

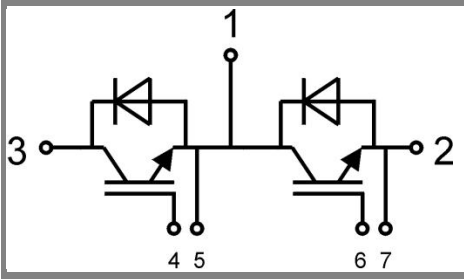

GB

Case D 56

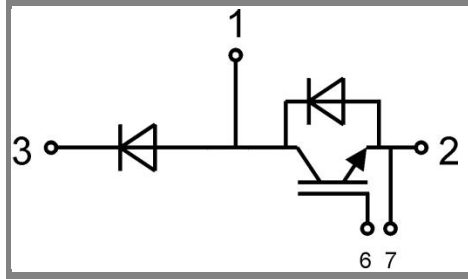

GAL

Case D 57 (→ D 56)

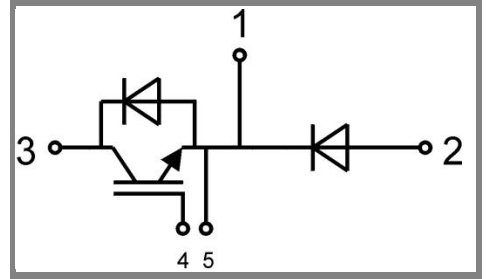

GAR

Case D 58 (→ D 56)