

# SKM150GAR12T4



SEMITRANS® 2

## Fast IGBT4 Modules

### SKM150GAR12T4

#### Features

- IGBT4 = 4. Generation (Trench) IGBT
- $V_{CEsat}$  with positive temperature coefficient
- High short circuit capability, selflimiting to  $6 \times I_{Cnom}$
- Soft switching 4. Generation CALdiode (CAL4)
- UL recognized, file no. E63532

#### Typical Applications\*

- Electronic welders
- DC/DC – converter
- Brake chopper
- Switched reluctance motor

#### Remarks

- Case temperature limited to  $T_c = 125^\circ\text{C}$  max, recomm.  $T_{op} = -40 \dots +150^\circ\text{C}$ , product rel. results valid for  $T_j = 150^\circ$

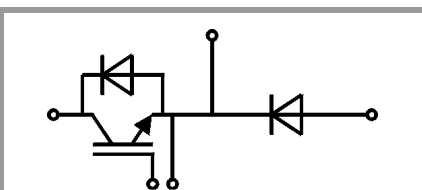

GAR

Absolute Maximum Ratings				
Symbol	Conditions		Values	Unit
<b>IGBT</b>				
$V_{CES}$	$T_j = 25^\circ\text{C}$		1200	V
$I_C$	$T_j = 175^\circ\text{C}$	$T_c = 25^\circ\text{C}$	232	A
		$T_c = 80^\circ\text{C}$	179	A
$I_{Cnom}$			150	A
$I_{CRM}$	$I_{CRM} = 3 \times I_{Cnom}$		450	A
$V_{GES}$			-20 ... 20	V
$t_{psc}$	$V_{CC} = 800\text{ V}$	$T_j = 150^\circ\text{C}$	10	$\mu\text{s}$
	$V_{GE} \leq 15\text{ V}$			
	$V_{CES} \leq 1200\text{ V}$			
$T_j$			-40 ... 175	$^\circ\text{C}$
<b>Inverse diode</b>				
$I_F$	$T_j = 175^\circ\text{C}$	$T_c = 25^\circ\text{C}$	189	A
		$T_c = 80^\circ\text{C}$	141	A
$I_{Fnom}$			150	A
$I_{FRM}$	$I_{FRM} = 3 \times I_{Fnom}$		450	A
$I_{FSM}$	$t_p = 10\text{ ms, sin } 180^\circ, T_j = 25^\circ\text{C}$		900	A
$T_j$			-40 ... 175	$^\circ\text{C}$
<b>Freewheeling diode</b>				
$I_F$	$T_j = 175^\circ\text{C}$	$T_c = 25^\circ\text{C}$	189	A
		$T_c = 80^\circ\text{C}$	141	A
$I_{Fnom}$			150	A
$I_{FRM}$	$I_{FRM} = 3 \times I_{Fnom}$		450	A
$I_{FSM}$	$t_p = 10\text{ ms, sin } 180^\circ, T_j = 25^\circ\text{C}$		900	A
$T_j$			-40 ... 175	$^\circ\text{C}$
<b>Module</b>				
$I_{t(RMS)}$	$T_{terminal} = 80^\circ\text{C}$		200	A
$T_{stg}$			-40 ... 125	$^\circ\text{C}$
$V_{isol}$	AC sinus 50 Hz, $t = 1\text{ min}$		4000	V

Characteristics						
Symbol	Conditions		min.	typ.	max.	Unit
<b>IGBT</b>						
$V_{CE(sat)}$	$I_C = 150\text{ A}$ $V_{GE} = 15\text{ V}$ chipelevel	$T_j = 25^\circ\text{C}$	1.80	2.05		V
		$T_j = 150^\circ\text{C}$	2.20	2.40		V
$V_{CE0}$	chipelevel	$T_j = 25^\circ\text{C}$	0.8	0.9		V
		$T_j = 150^\circ\text{C}$	0.7	0.8		V
$r_{CE}$	$V_{GE} = 15\text{ V}$ chipelevel	$T_j = 25^\circ\text{C}$	6.67	7.67		$\text{m}\Omega$
		$T_j = 150^\circ\text{C}$	10.00	10.67		$\text{m}\Omega$
$V_{GE(th)}$	$V_{GE} = V_{CE}, I_C = 6\text{ mA}$		5	5.8	6.5	V
$I_{CES}$	$V_{GE} = 0\text{ V}$ $V_{CE} = 1200\text{ V}$	$T_j = 25^\circ\text{C}$	0.1	0.3		mA
		$T_j = 150^\circ\text{C}$				mA
$C_{ies}$	$V_{CE} = 25\text{ V}$ $V_{GE} = 0\text{ V}$	$f = 1\text{ MHz}$	9.3			nF
$C_{oes}$		$f = 1\text{ MHz}$	0.58			nF
$C_{res}$		$f = 1\text{ MHz}$	0.51			nF
$Q_G$	$V_{GE} = -8\text{ V} \dots +15\text{ V}$		850			nC
$R_{Gint}$	$T_j = 25^\circ\text{C}$		5.00			$\Omega$

# SKM150GAR12T4



SEMITRANS® 2

## Fast IGBT4 Modules

### SKM150GAR12T4

#### Features

- IGBT4 = 4. Generation (Trench) IGBT
- $V_{CEsat}$  with positive temperature coefficient
- High short circuit capability, selflimiting to  $6 \times I_{CNOM}$
- Soft switching 4. Generation CALdiode (CAL4)
- UL recognized, file no. E63532

#### Typical Applications\*

- Electronic welders
- DC/DC – converter
- Brake chopper
- Switched reluctance motor

#### Remarks

- Case temperature limited to  $T_c = 125^\circ\text{C}$  max, recomm.  $T_{op} = -40 \dots +150^\circ\text{C}$ , product rel. results valid for  $T_j = 150^\circ$

Characteristics						
Symbol	Conditions		min.	typ.	max.	Unit
$t_{d(on)}$	$V_{CC} = 600\text{ V}$	$T_j = 150^\circ\text{C}$		180		ns
$t_r$	$I_C = 150\text{ A}$	$T_j = 150^\circ\text{C}$		42		ns
$E_{on}$	$V_{GE} = \pm 15\text{ V}$	$T_j = 150^\circ\text{C}$		19.2		mJ
$t_{d(off)}$	$R_{G\ on} = 1\ \Omega$	$T_j = 150^\circ\text{C}$		410		ns
$t_f$	$R_{G\ off} = 1\ \Omega$	$T_j = 150^\circ\text{C}$		72		ns
$E_{off}$	$di/dt_{on} = 3400\text{ A}/\mu\text{s}$	$T_j = 150^\circ\text{C}$		15.8		mJ
	$di/dt_{off} = 1750\text{ A}/\mu\text{s}$	$T_j = 150^\circ\text{C}$				
$R_{th(j-c)}$	per IGBT				0.19	K/W
Inverse diode						
$V_F = V_{EC}$	$I_F = 150\text{ A}$	$T_j = 25^\circ\text{C}$		2.14	2.46	V
	$V_{GE} = 0\text{ V}$	$T_j = 150^\circ\text{C}$		2.07	2.38	V
	chiplevel					
$V_{F0}$		$T_j = 25^\circ\text{C}$		1.3	1.5	V
	chiplevel	$T_j = 150^\circ\text{C}$		0.9	1.1	V
$r_F$		$T_j = 25^\circ\text{C}$		5.6	6.4	m $\Omega$
	chiplevel	$T_j = 150^\circ\text{C}$		7.8	8.5	m $\Omega$
$I_{RRM}$	$I_F = 150\text{ A}$	$T_j = 150^\circ\text{C}$		120		A
$Q_{rr}$	$di/dt_{off} = 3100\text{ A}/\mu\text{s}$	$T_j = 150^\circ\text{C}$		31.3		$\mu\text{C}$
$E_{rr}$	$V_{GE} = \pm 15\text{ V}$	$T_j = 150^\circ\text{C}$		13		mJ
	$V_{CC} = 600\text{ V}$	$T_j = 150^\circ\text{C}$				
$R_{th(j-c)}$	per diode				0.31	K/W
Freewheeling diode						
$V_F = V_{EC}$	$I_F = 150\text{ A}$	$T_j = 25^\circ\text{C}$		2.14	2.46	V
	$V_{GE} = 0\text{ V}$	$T_j = 150^\circ\text{C}$		2.07	2.38	V
	chiplevel					
$V_{F0}$		$T_j = 25^\circ\text{C}$		1.3	1.5	V
	chiplevel	$T_j = 150^\circ\text{C}$		0.9	1.1	V
$r_F$		$T_j = 25^\circ\text{C}$		5.6	6.4	m $\Omega$
	chiplevel	$T_j = 150^\circ\text{C}$		7.8	8.5	m $\Omega$
$I_{RRM}$	$I_F = 150\text{ A}$	$T_j = 150^\circ\text{C}$		120		A
$Q_{rr}$	$di/dt_{off} = 3100\text{ A}/\mu\text{s}$	$T_j = 150^\circ\text{C}$		31.3		$\mu\text{C}$
$E_{rr}$	$V_{GE} = \pm 15\text{ V}$	$T_j = 150^\circ\text{C}$		13		mJ
	$V_{CC} = 600\text{ V}$	$T_j = 150^\circ\text{C}$				
$R_{th(j-c)}$	per Diode				0.31	K/W
Module						
$L_{CE}$					30	nH
$R_{CC'+EE'}$	terminal-chip	$T_c = 25^\circ\text{C}$		0.65		m $\Omega$
		$T_c = 125^\circ\text{C}$		1		m $\Omega$
$R_{th(c-s)}$	per module			0.04	0.05	K/W
$M_s$	to heat sink M6			3	5	Nm
$M_t$		to terminals M5		2.5	5	Nm
						Nm
w					160	g

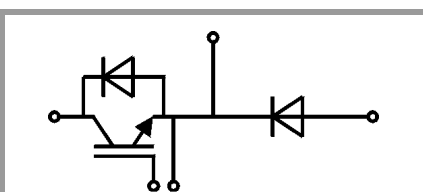

GAR

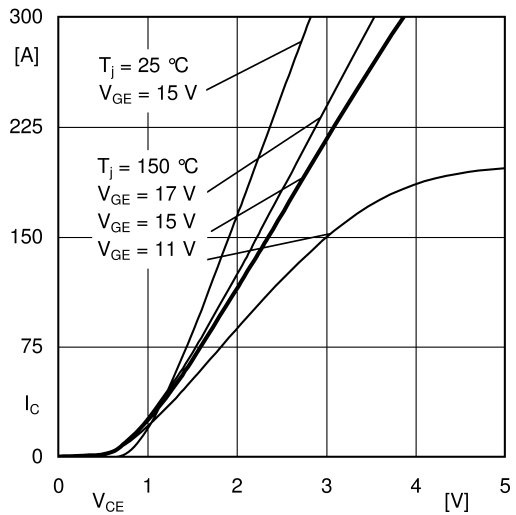

Fig. 1: Typ. output characteristic, inclusive  $R_{CC'+EE'}$

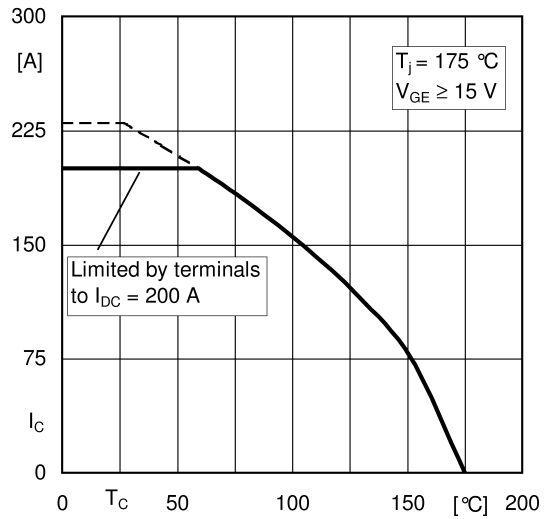

Fig. 2: Rated current vs. temperature  $I_C = f(T_C)$

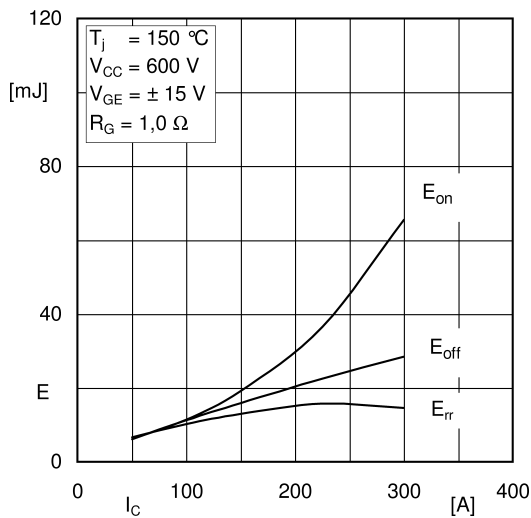

Fig. 3: Typ. turn-on /-off energy =  $f(I_C)$

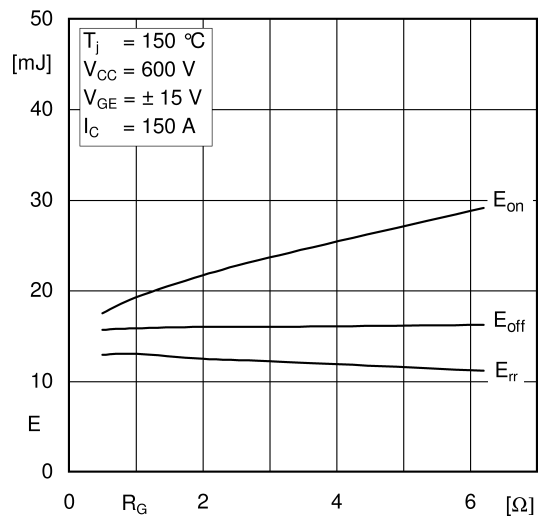

Fig. 4: Typ. turn-on /-off energy =  $f(R_G)$

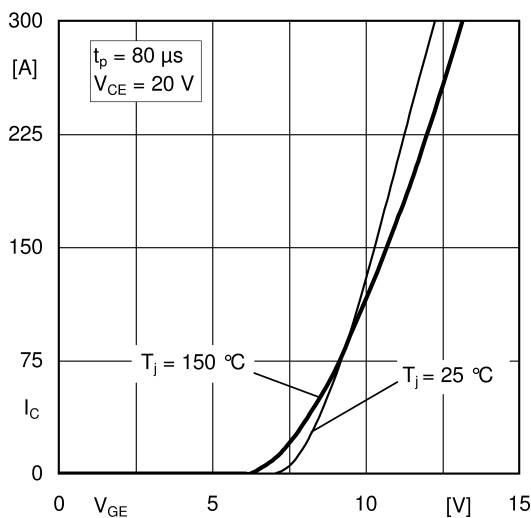

Fig. 5: Typ. transfer characteristic

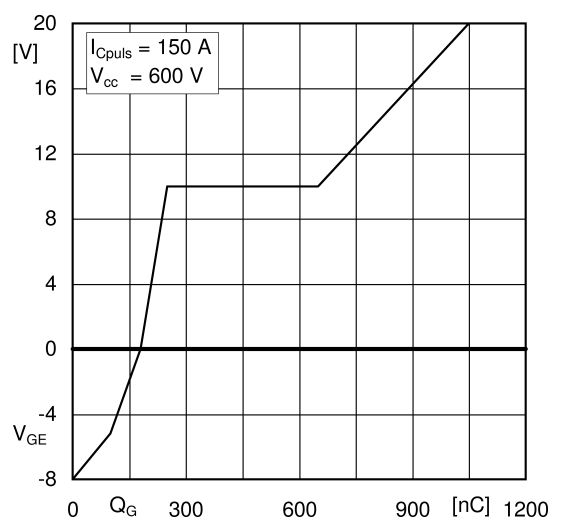

Fig. 6: Typ. gate charge characteristic

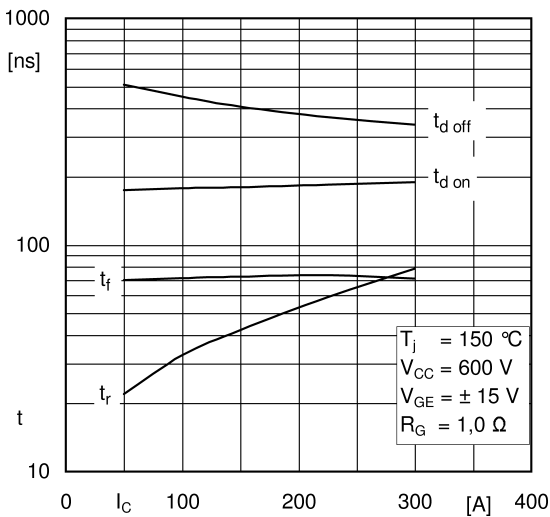

Fig. 7: Typ. switching times vs.  $I_C$

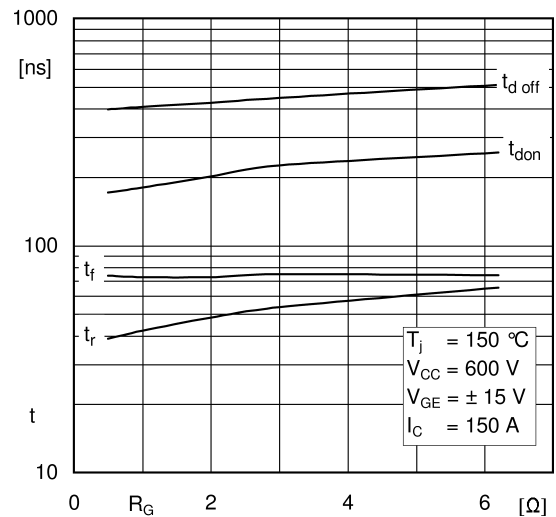

Fig. 8: Typ. switching times vs. gate resistor  $R_G$

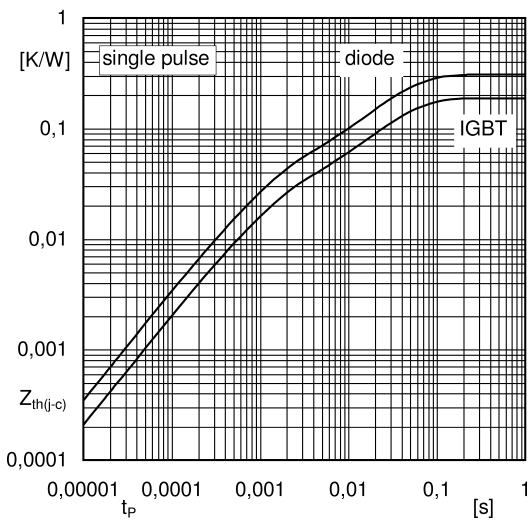

Fig. 9: Transient thermal impedance

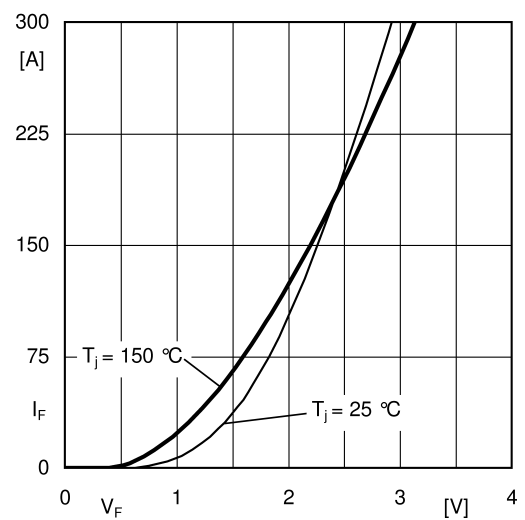

Fig. 10: Typ. CAL diode forward charact., incl.  $R_{CC+EE}$

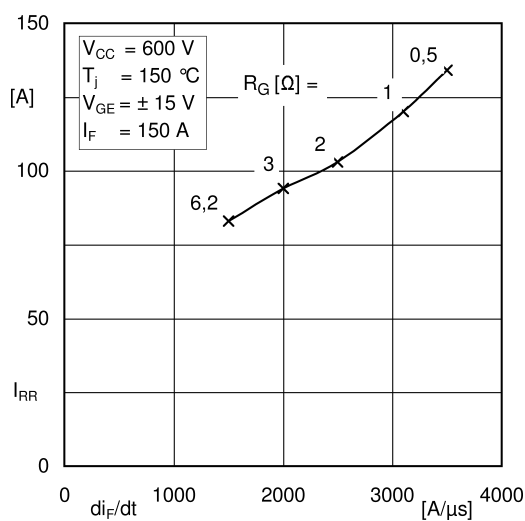

Fig. 11: CAL diode peak reverse recovery current

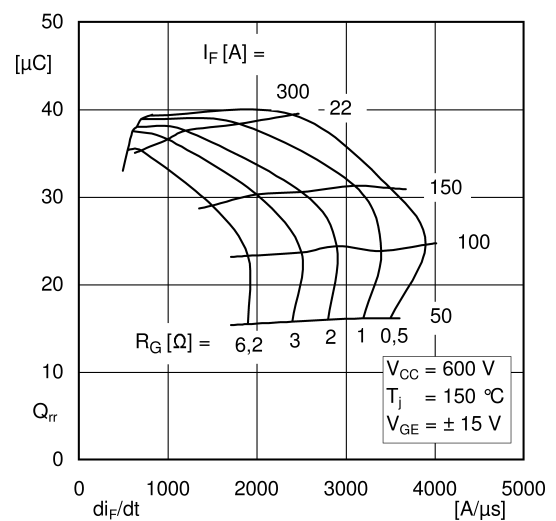
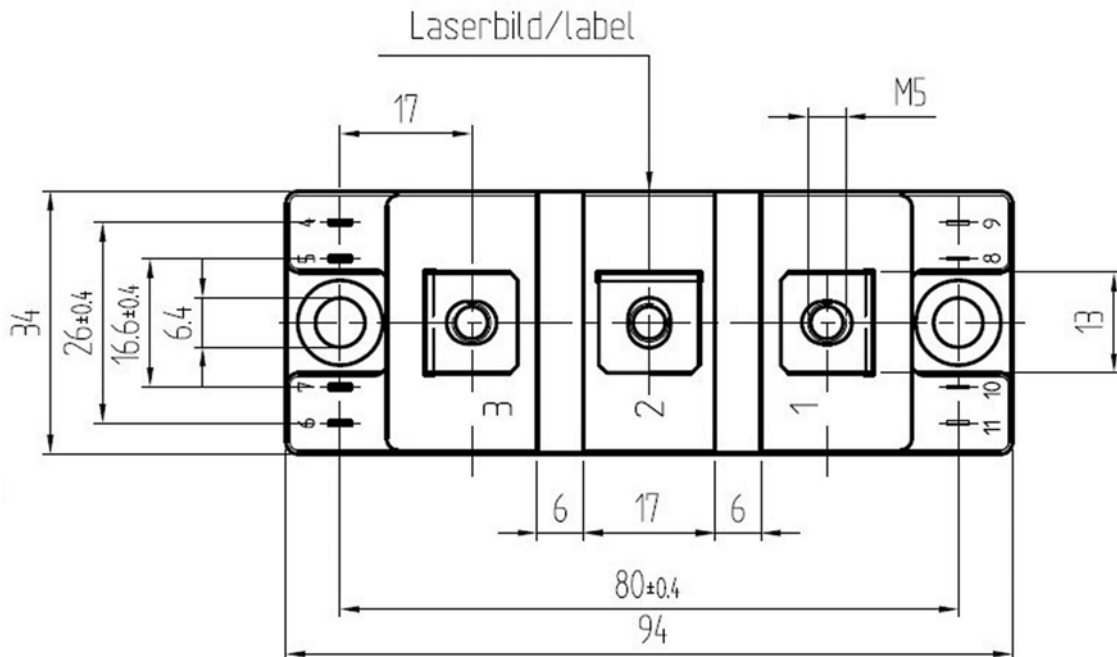
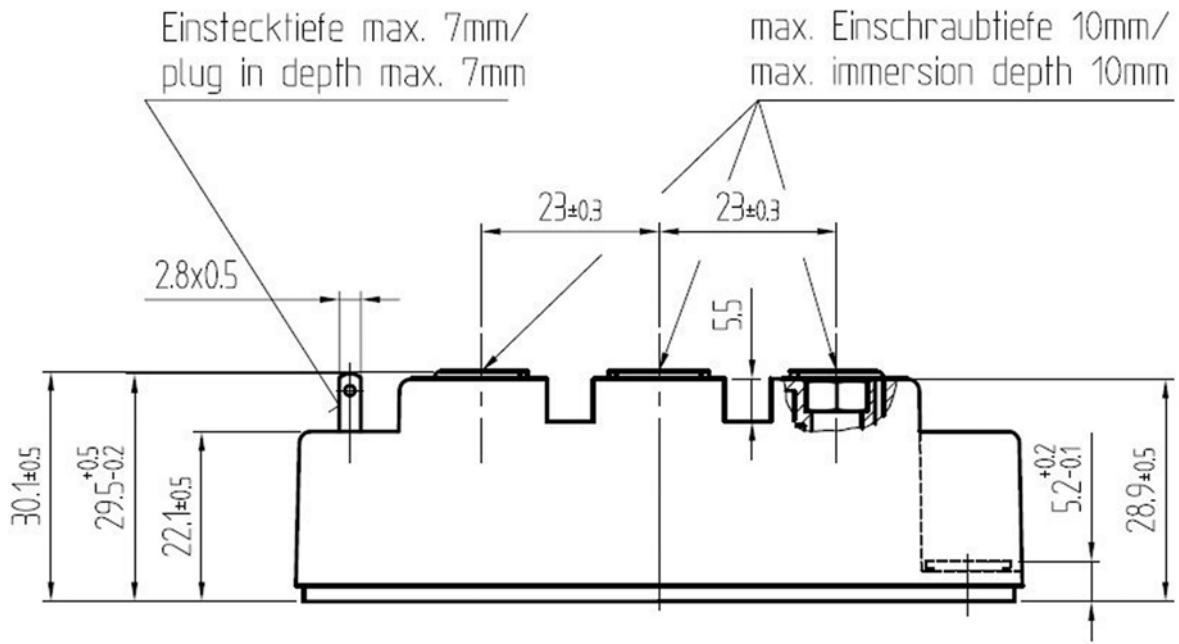
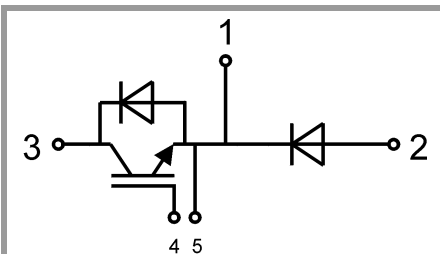

Fig. 12: Typ. CAL diode peak reverse recovery charge

# SKM150GAR12T4



SEMITRANS 2



GAR

This is an electrostatic discharge sensitive device (ESDS), international standard IEC 60747-1, Chapter IX

\* The specifications of our components may not be considered as an assurance of component characteristics. Components have to be tested for the respective application. Adjustments may be necessary. The use of SEMIKRON products in life support appliances and systems is subject to prior specification and written approval by SEMIKRON. We therefore strongly recommend prior consultation of our staff.