

PRODUCT FEATURES

- Ultrafast Reverse Recovery Time
- Soft Reverse Recovery Characteristics
- Low Reverse Recovery Loss
- High System Power Density
- Popular SOT-227 Package

APPLICATIONS

- Inversion Welder
- Uninterruptible Power Supply (UPS)
- Plating Power Supply
- Ultrasonic Cleaner and Welder
- Converter & Chopper
- Power Factor Correction (PFC) Circuit

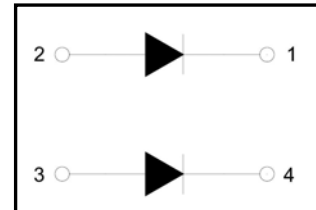

ABSOLUTE MAXIMUM RATINGS

$T_C=25^{\circ}\text{C}$ unless otherwise specified

Symbol	Parameter	Test Conditions	Values	Unit
V_R	Maximum D.C. Reverse Voltage		600	V
V_{RRM}	Maximum Repetitive Reverse Voltage		600	V
$I_{F(AV)}$	Average Forward Current	$T_C=90^{\circ}\text{C}$, Per Diode	100	A
		$T_C=90^{\circ}\text{C}$, Per Moudle	200	A
		$T_C=100^{\circ}\text{C}$, 20KHz, Per Moudle	150	A
$I_{F(RMS)}$	RMS Forward Current	$T_C=90^{\circ}\text{C}$, Per Diode	150	A
I_{FSM}	Non-Repetitive Surge Forward Current	1/2 Cycle , 50Hz, Sine	1500	A
		1/2 Cycle , 60Hz, Sine	1800	A
I^2t	I^2t (For Fusing)	$T_J=45^{\circ}\text{C}$, $t=10\text{ms}$, 50Hz, Sine	11250	A^2s
		$T_J=45^{\circ}\text{C}$, $t=8.3\text{ms}$, 60Hz, Sine	16200	A^2s
P_D	Power Dissipation		417	W
V_{isol}	Insulation Test Voltage	AC, $t=1\text{min}$	3000	V
T_J	Junction Temperature		-40 to +150	$^{\circ}\text{C}$
T_{STG}	Storage Temperature Range		-40 to +125	$^{\circ}\text{C}$
Torque	Module-to-Sink	Recommended (M4)	0.7~1.1	N·m
Torque	Module Electrodes	Recommended (M4)	0.7~1.1	N·m
$R_{\theta JC}$	Thermal Resistance	Junction-to-Case	0.30	$^{\circ}\text{C}/\text{W}$
Weight			26.5	g

ELECTRICAL CHARACTERISTICS

T_C=25°C unless otherwise specified

Symbol	Parameter	Test Conditions	Min.	Typ.	Max.	Unit
I _{RM}	Reverse Leakage Current	V _R =600V	--	--	1	mA
		V _R =600V, T _J =125°C	--	--	5	mA
V _F	Forward Voltage	I _F =100A	--	1.2	1.45	V
		I _F =100A, T _J =125°C	--	1.1	1.35	V
t _{rr}	Reverse Recovery Time	I _F =1A, V _R =30V, di _F /dt=-200A/μs	--	50	--	ns
t _{rr}	Reverse Recovery Time	V _R =300V, I _F =100A di _F /dt=-200A/μs, T _J =25°C	--	115	--	ns
I _{RRM}	Max. Reverse Recovery Current		--	13.5	--	A
t _{rr}	Reverse Recovery Time	V _R =300V, I _F =100A di _F /dt=-200A/μs, T _J =125°C	--	190	--	ns
I _{RRM}	Max. Reverse Recovery Current		--	19	--	A

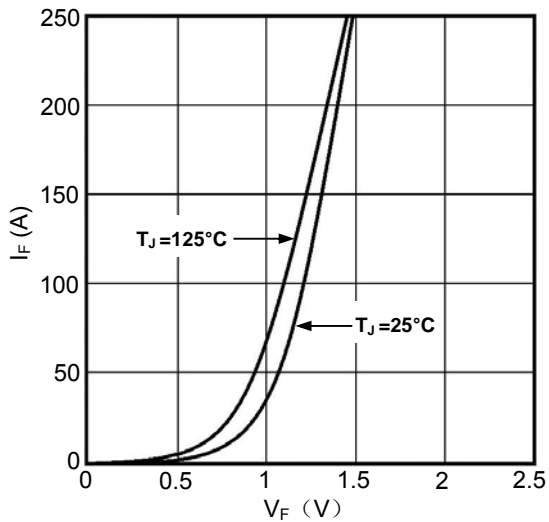

Figure1. Forward Voltage Drop vs Forward Current

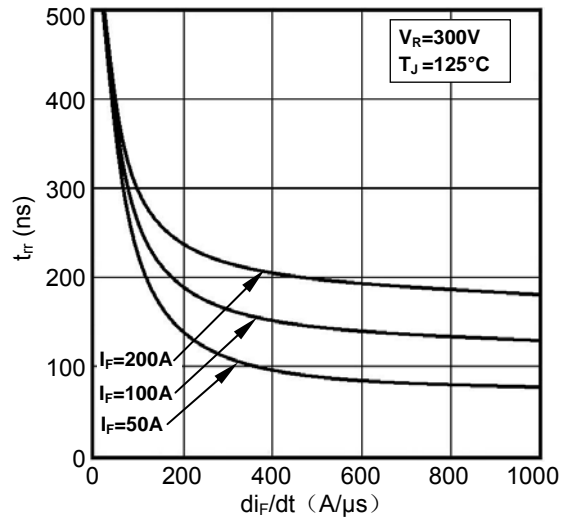

Figure2. Reverse Recovery Time vs di_F/dt

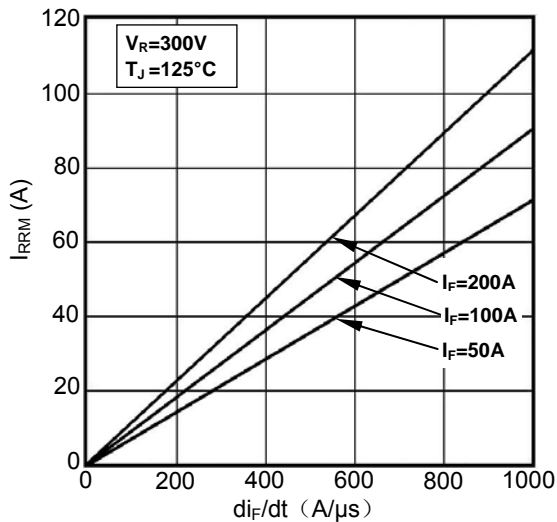

Figure3. Reverse Recovery Current vs di_F/dt

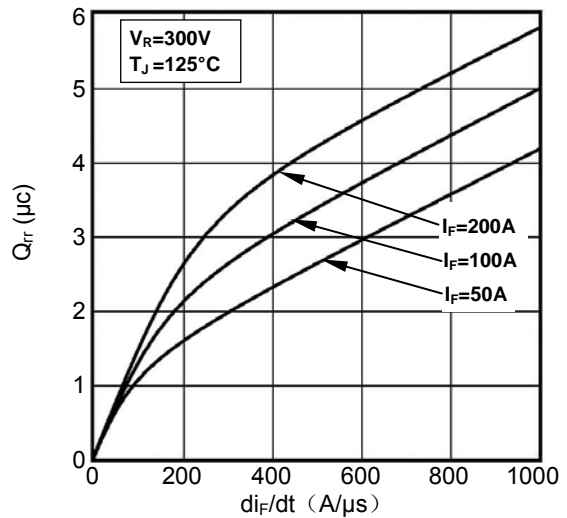

Figure4. Reverse Recovery Charge vs di_F/dt

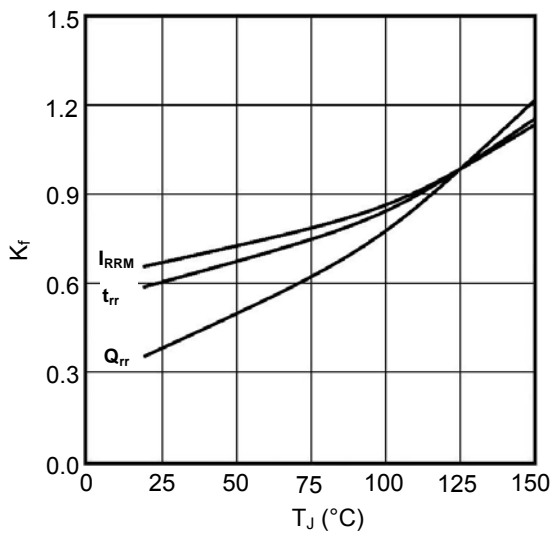

Figure5. Dynamic Parameters vs Junction Temperature

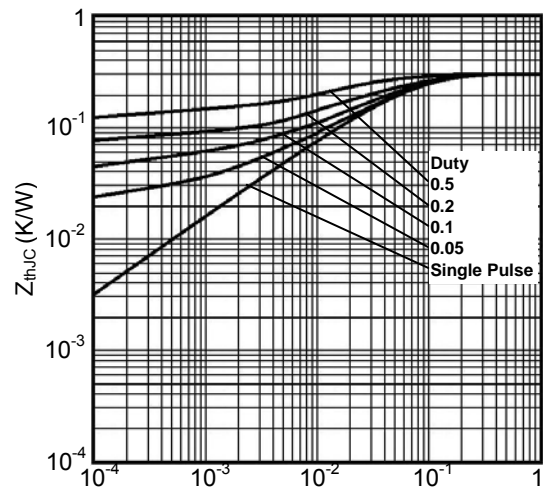
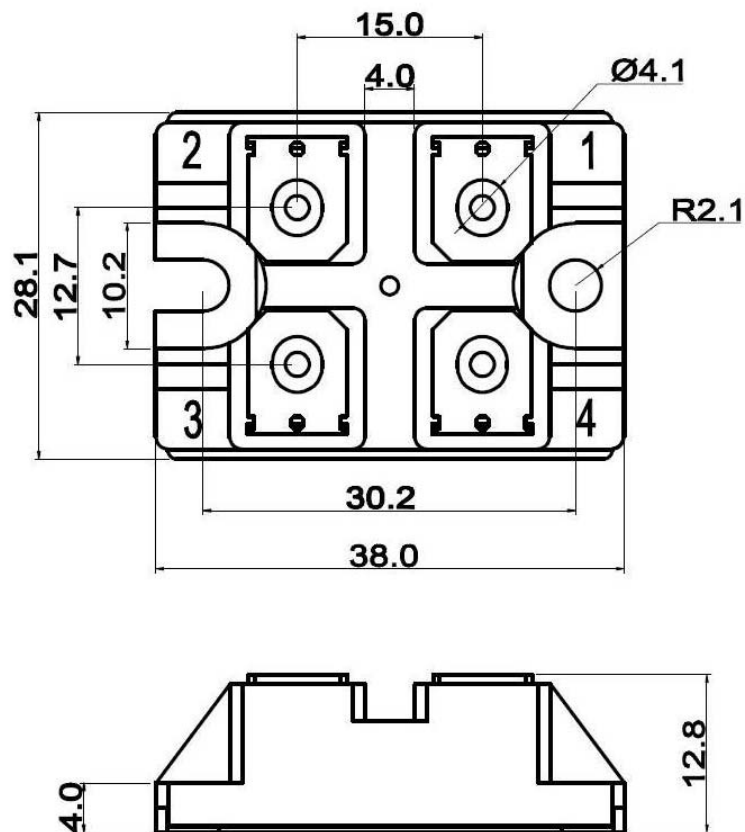

Figure6. Transient Thermal Impedance



Dimensions (mm)
Figure7. Package Outline