

Features

- Isolated Module Package
- Isolation voltage 3000 V
- Three Phase Bridge and a Thyristor



Applications

- Current Stabilized Power Supply
- Switching Power Supply
- Inverter For AC or DC Motor Control

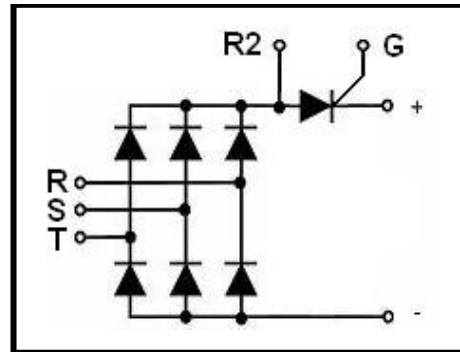

■ Diode

ABSOLUTE MAXIMUM RATINGS

 $T_C=25^{\circ}\text{C}$ unless otherwise specified

Symbol	Parameter	Test Conditions	Max.	Unit
V_{RRM}	Repetitive Reverse Voltage		1600	V
$I_{D(AV)}$	Average Forward Current	$T_C=90^{\circ}\text{C}$, module	150	A
I_{FSM}	Non-Repetitive Surge Forward Current	$T_J=45^{\circ}\text{C}$, $t=10\text{ms}$, 50Hz, Sine	1700	A
		$T_J=45^{\circ}\text{C}$, $t=8.3\text{ms}$, 60Hz, Sine	1900	A
I^2t	I^2t (For Fusing)	$T_J=45^{\circ}\text{C}$, $t=10\text{ms}$, 50Hz, Sine	14450	A^2s
		$T_J=45^{\circ}\text{C}$, $t=8.3\text{ms}$, 60Hz, Sine	18050	A^2s
T_J	Junction Temperature		-40 to +150	$^{\circ}\text{C}$
T_{STG}	Storage Temperature Range		-40 to +125	$^{\circ}\text{C}$
V_{isol}	Insulation Test Voltage	AC, 50Hz, $t=1\text{min}$	3000	V
Weight			332	g

ELECTRICAL AND THERMAL CHARACTERISTICS

 $T_C=25^{\circ}\text{C}$ unless otherwise specified

Symbol	Parameter	Test Conditions	Min.	Typ.	Max.	Unit
I_{RM}	Reverse Leakage Current	$V_R=1600\text{V}$	--	--	500	μA
		$V_R=1600\text{V}$, $T_J=125^{\circ}\text{C}$	--	--	5	mA
V_F	Forward Voltage	$I_F=150\text{A}$	--	1.4	1.7	V
		$I_F=150\text{A}$, $T_J=125^{\circ}\text{C}$	--	1.3	--	V
$R_{\theta JC}$	Thermal Resistance Junction-to-Case	per diode	--	--	0.72	$^{\circ}\text{C}/\text{W}$
		per module	--	--	0.12	$^{\circ}\text{C}/\text{W}$
$R_{\theta CS}$	Thermal Resistance Case -to-Sink	per diode	--	--	0.36	$^{\circ}\text{C}/\text{W}$
		per module	--	--	0.06	$^{\circ}\text{C}/\text{W}$

MacMic Science & Technology Co., Ltd.

Add: #18, Hua Shan Zhong Lu, New District, Changzhou City, Jiangsu Province, P. R. of China

Tel.: +86-519-85163708 Fax: +86-519-85162291 Post Code: 213022 Website: www.macmicst.com

■ Thyristor

ABSOLUTE MAXIMUM RATINGS $T_C=25^{\circ}\text{C}$ unless otherwise specified

Symbol	Test Condition	Value	Unit
V_{RRM}		1600	V
$I_{T(AV)}$	$T_C=90^{\circ}\text{C}$, 180° conduction, half sine wave;	150	A
I_{TSM}	$T_J=45^{\circ}\text{C}$, $t=10\text{ms}$ (50Hz), sine, $V_R=V_{RRM}$;	1700	A
	$T_J=45^{\circ}\text{C}$, $t=8.3\text{ms}$ (60Hz), sine, $V_R=V_{RRM}$;	1900	
I^2t	$T_J=45^{\circ}\text{C}$, $t=10\text{ms}$ (50Hz), sine, $V_R=V_{RRM}$;	14450	A^2s
	$T_J=45^{\circ}\text{C}$, $t=8.3\text{ms}$ (60Hz), sine, $V_R=V_{RRM}$;	18050	
dV/dt	$T_J=125^{\circ}\text{C}$, exponential to 67% rated V_{DRM}	1000	V/us
dI/dt	$T_J=125^{\circ}\text{C}$, $I_{TM}=400\text{A}$ rated V_{DRM}	200	A/us
V_{ISOL}	50Hz, all terminals shorted, $t=1\text{s}$, $I_{ISOL}\leq 1\text{mA}$;	3000	V~
T_J	Max. junction operating temperature range	-40~125	$^{\circ}\text{C}$
T_{STG}	Max. storage temperature range	-40~125	$^{\circ}\text{C}$
	Mounting torque(M6)	3 to 5	N·m
	Terminal connection torque(M6)	3 to 5	N·m
	Terminal connection torque(M4)	1 to 2	N·m

ELECTRICAL AND THERMAL CHARACTERISTICS $T_C=25^{\circ}\text{C}$ unless otherwise specified

Symbol	Test Condition	Min.	Typ.	Max.	Unit
I_{DRM}/I_{RRM}	$T_J=125^{\circ}\text{C}$, $V_D=V_R=1600\text{V}$;			50	mA
V_{TM}	$I_{TM}=502\text{A}$, $t_d=10\text{ms}$, half sine;		1.54		V
V_{GT}	$V_A=6\text{V}$, $R_A=1\Omega$, $T_J=-40^{\circ}\text{C}$;			4	V
	$V_A=6\text{V}$, $R_A=1\Omega$;			2.5	
	$V_A=6\text{V}$, $R_A=1\Omega$, $T_J=125^{\circ}\text{C}$;			1.7	
I_{GT}	$V_A=6\text{V}$, $R_A=1\Omega$, $T_J=-40^{\circ}\text{C}$;			270	mA
	$V_A=6\text{V}$, $R_A=1\Omega$;			150	
	$V_A=6\text{V}$, $R_A=1\Omega$, $T_J=125^{\circ}\text{C}$;			80	
P_{GM}	$t_p\leq 5\text{ms}$, $T_J=125^{\circ}\text{C}$;			12	W
$P_{GM(AV)}$	$f=50\text{Hz}$, $T_J=125^{\circ}\text{C}$;			3	W
R_{thjc}	Thermal Resistance , Junction-to-Case			0.18	K/W
R_{THCS}	Thermal Resistance, Case -to-Sink			0.08	K/W

Characteristic curves

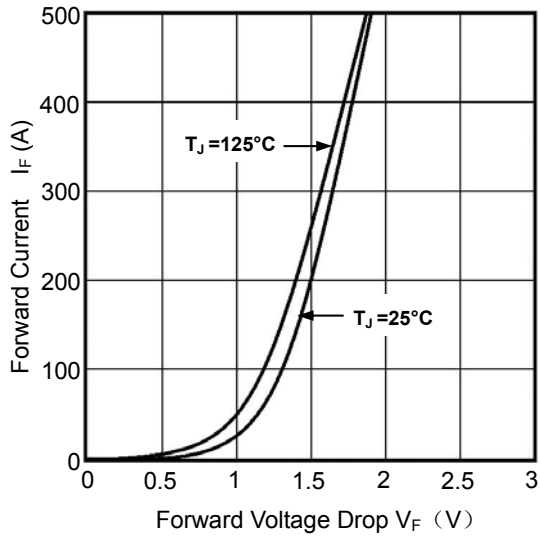

Figure 1. Diode Forward Voltage Drop vs Forward Current

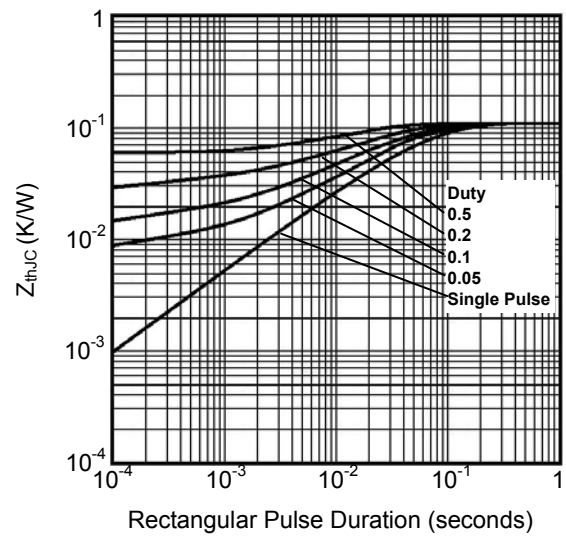

Figure 2. Diode Thermal Impedance Z_{thJC}

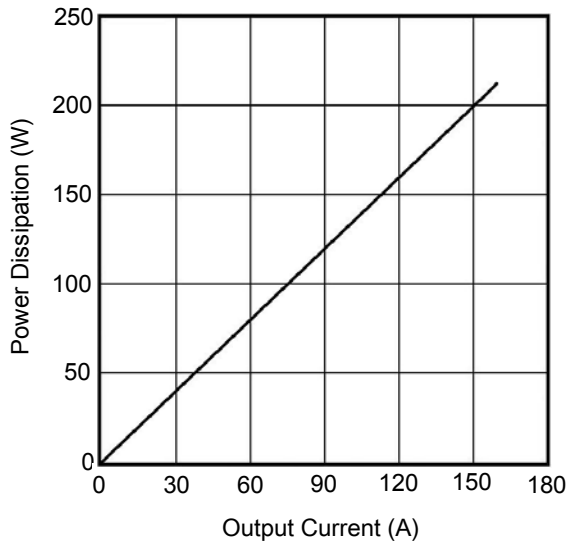

Figure 3. SCR Output Current vs Power Dissipation

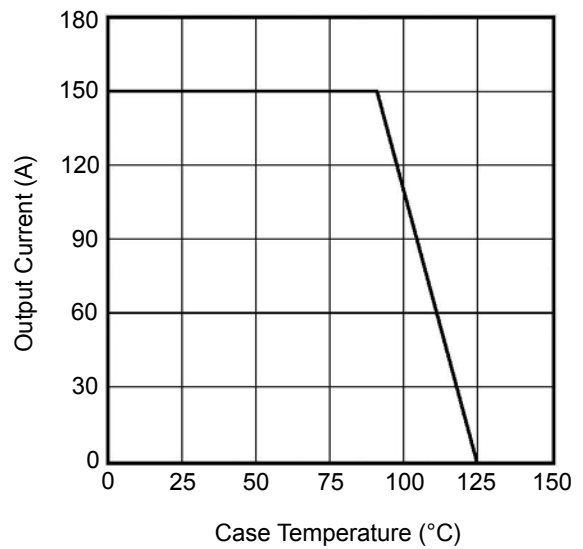

Figure 4. SCR Output Current vs Case Temperature

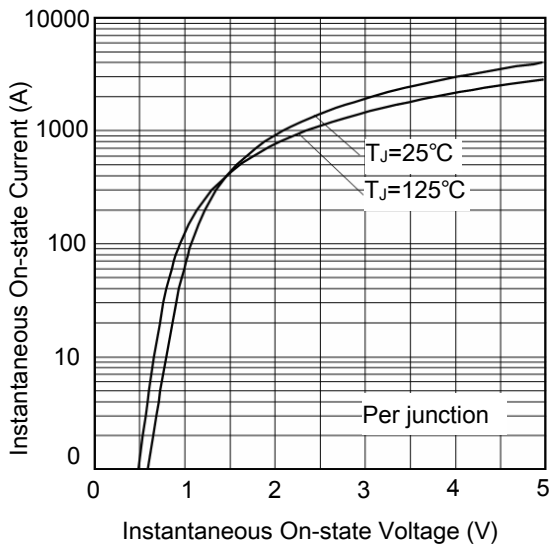

Figure 5. SCR On State Voltage Drop

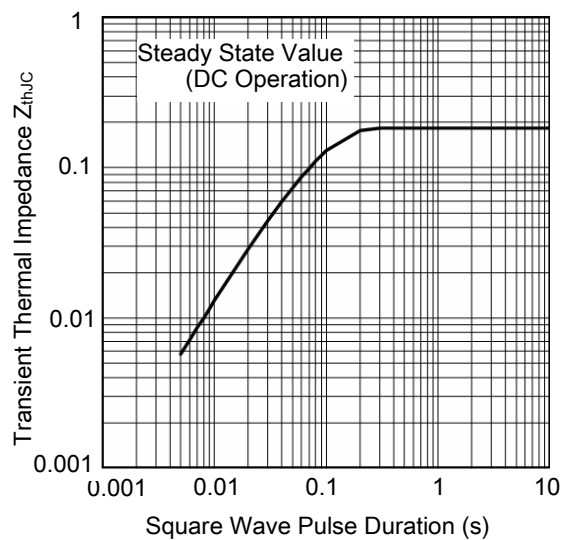

Figure 6. SCR Thermal Impedance Z_{thJC}

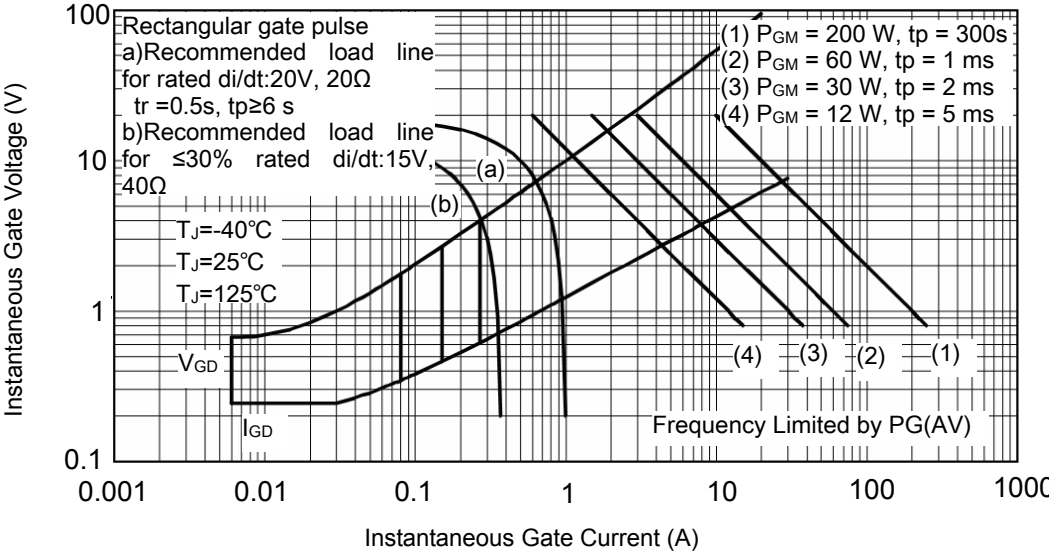

Figure 7. Gate Characteristics

Package Outline (Dimensions in mm)

