

# SKKT 172, SKKH 172



**SEMIPACK<sup>®</sup> 2**

## Thyristor / Diode Modules

**SKKH 172**

**SKKT 172**

### Features

- Heat transfer through aluminium oxide ceramic isolated metal baseplate
- Hard soldered joints for high reliability
- UL recognized, file no. E 63 532

### Typical Applications\*

- DC motor control (e.g. for machine tools)
- AC motor soft starters

1) Characteristic values

2) See the assembly instructions

$V_{RSM}$ V	$V_{RRM}, V_{DRM}$ V	$I_{TRMS} = 275$ A (maximum value for continuous operation) $I_{TAV} = 172$ A (sin. 180; $T_c = 86$ °C)	
1500	1400	SKKT 172/14E	
1700	1600	SKKT 172/16E	SKKH 172/16E
1900	1800	SKKT 172/18E	

Symbol	Conditions	Values	Units
$I_{TAV}$	sin. 180; $T_c = 85$ (100) °C;	175 (124)	A
$I_{TSM}$	$T_{vj} = 25$ °C; 10 ms $T_{vj} = 125$ °C; 10 ms	5400 5000	A A
$i^2t$	$T_{vj} = 25$ °C; 8,3 ... 10 ms $T_{vj} = 125$ °C; 8,3 ... 10 ms	145000 125000	A <sup>2</sup> s A <sup>2</sup> s
$V_T$	$T_{vj} = 25$ °C; $I_T = 500$ A	max. 1,41	V
$V_{T(TO)}$	$T_{vj} = 125$ °C	max. 0,83	V
$r_T$	$T_{vj} = 125$ °C	max. 1,3	mΩ
$V_{T(TO)(typ.)}^{1)}$	$T_{vj} = 125$ °C	0,8	V
$r_{T(typ.)}^{1)}$	$T_{vj} = 125$ °C	1,2	mΩ
$I_{DD}, I_{RD}$	$T_{vj} = 125$ °C; $V_{RD} = V_{RRM}; V_{DD} = V_{DRM}$	max. 40	mA
$t_{gd}$	$T_{vj} = 25$ °C; $I_G = 1$ A; $di_G/dt = 1$ A/μs	1	μs
$t_{gr}$	$V_D = 0,67 * V_{DRM}$	2	μs
$(di/dt)_{cr}$	$T_{vj} = 125$ °C	max. 200	A/μs
$(dv/dt)_{cr}$	$T_{vj} = 125$ °C	max. 1000	V/μs
$t_q$	$T_{vj} = 125$ °C	typ. 175	μs
$I_H$	$T_{vj} = 25$ °C; typ. / max.	150 / 400	mA
$I_L$	$T_{vj} = 25$ °C; $R_G = 33$ Ω; typ. / max.	300 / 1000	mA
$V_{GT}$	$T_{vj} = 25$ °C; d.c.	min. 2	V
$I_{GT}$	$T_{vj} = 25$ °C; d.c.	min. 150	mA
$V_{GD}$	$T_{vj} = 125$ °C; d.c.	max. 0,25	V
$I_{GD}$	$T_{vj} = 125$ °C; d.c.	max. 10	mA
$R_{th(j-c)}$	cont.; per thyristor / per module	0,155 / 0,078	K/W
$R_{th(j-c)}$	sin. 180; per thyristor / per module	0,164 / 0,082	K/W
$R_{th(j-c)}$	rec. 120; per thyristor / per module	0,18 / 0,09	K/W
$R_{th(c-s)}$	per thyristor / per module	0,1 / 0,05	K/W
$T_{vj}$		- 40 ... + 125	°C
$T_{stg}$		- 40 ... + 125	°C
$V_{isol}$	a. c. 50 Hz; r.m.s.; 1 s / 1 min.	3600 / 3000	V~
$M_s$	to heatsink	$5 \pm 15$ % <sup>2)</sup>	Nm
$M_t$	to terminal	$5 \pm 15$ %	Nm
$a$		$5 * 9,81$	m/s <sup>2</sup>
$m$	approx.	165	g
Case	SKKT SKKH	A 21 A 22	

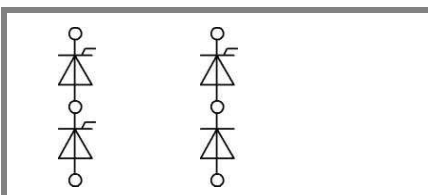

**SKKT**

**SKKH**

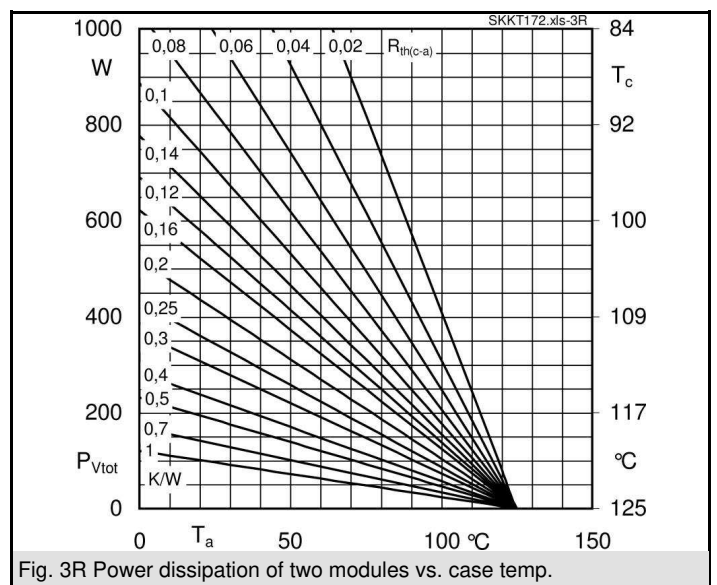
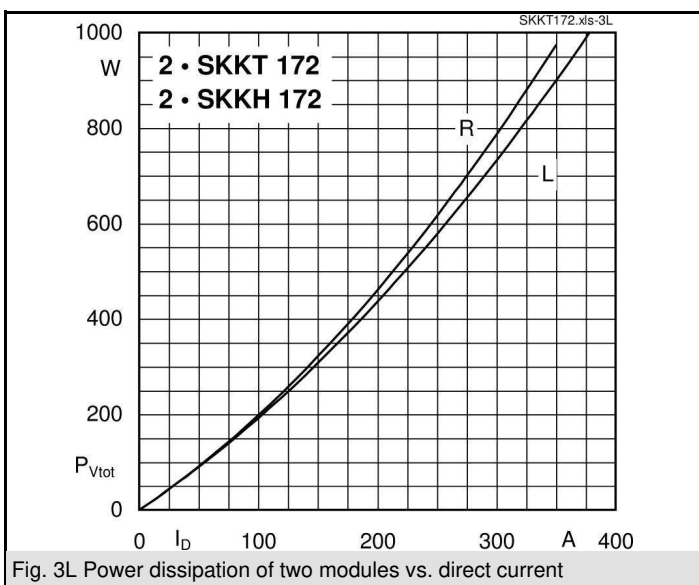
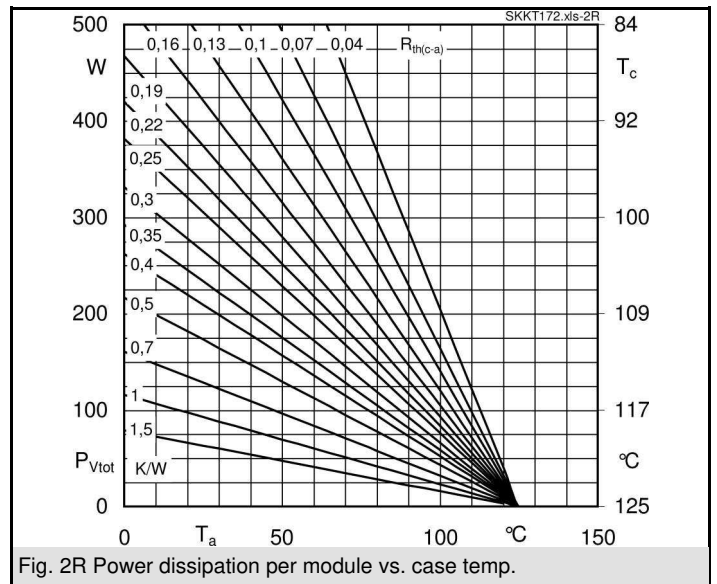
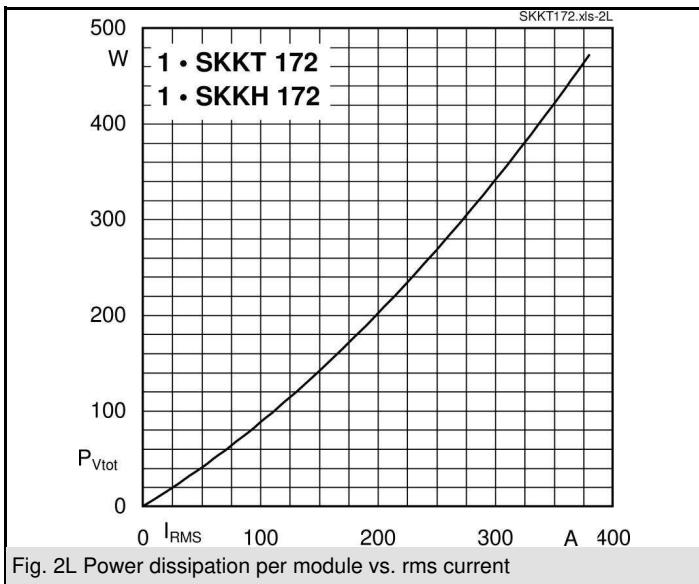
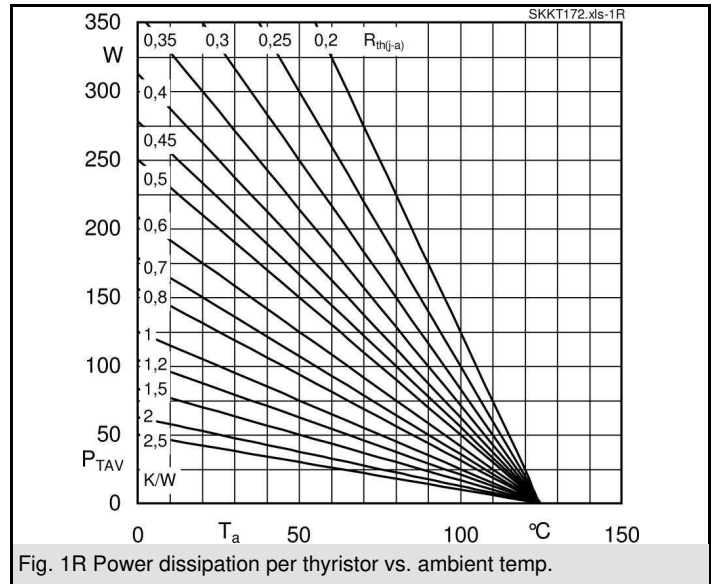
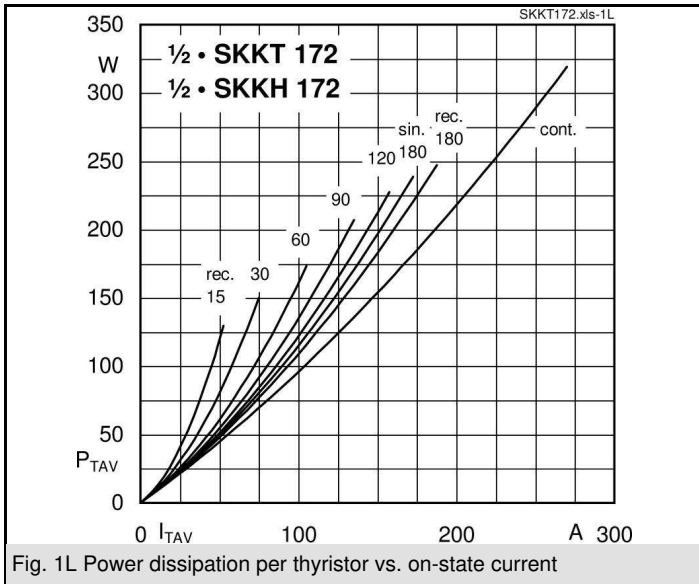

# SKKT 172, SKKH 172

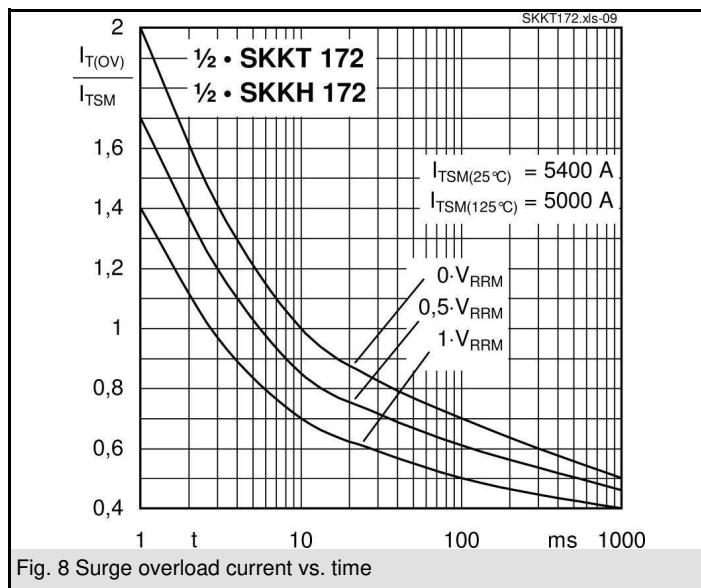
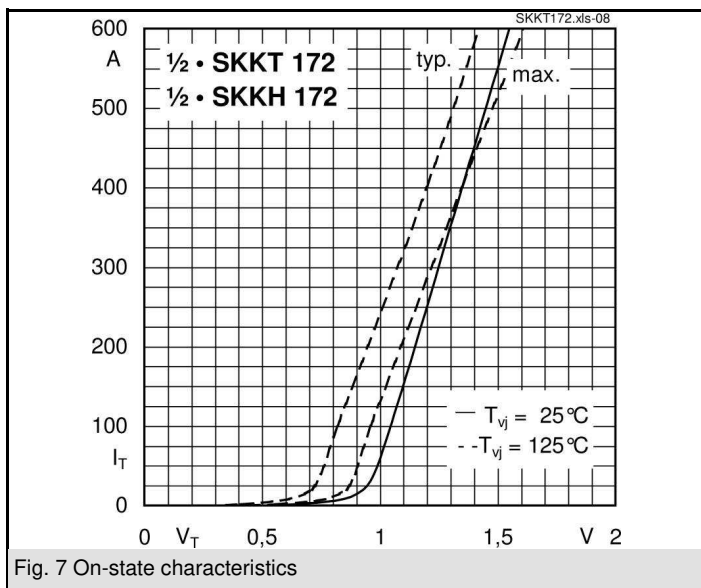
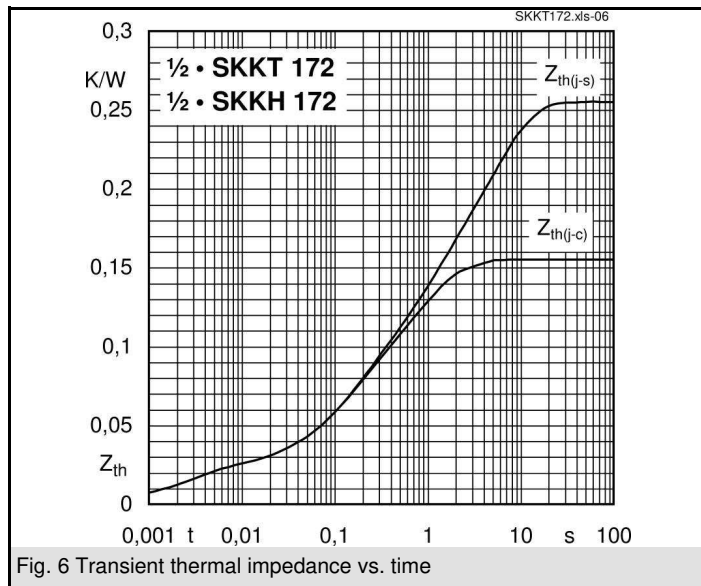
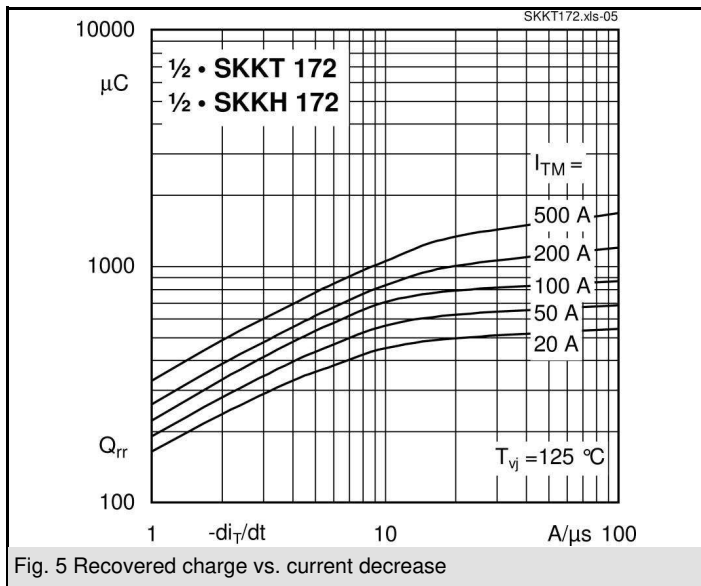
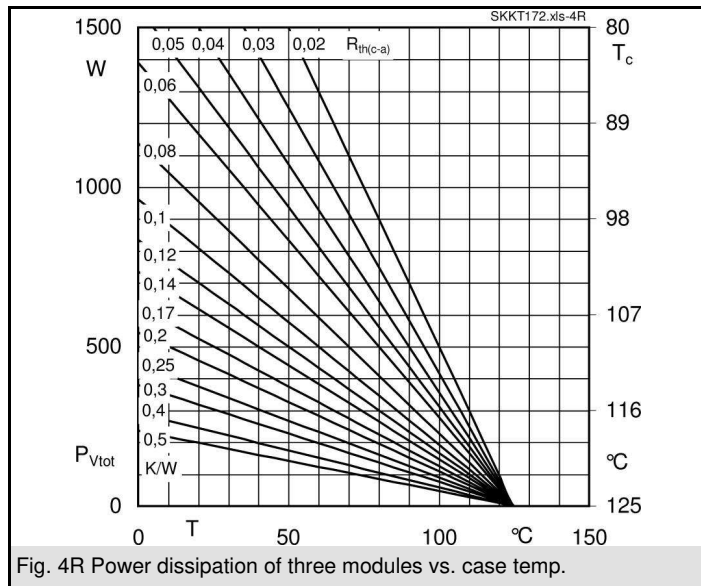
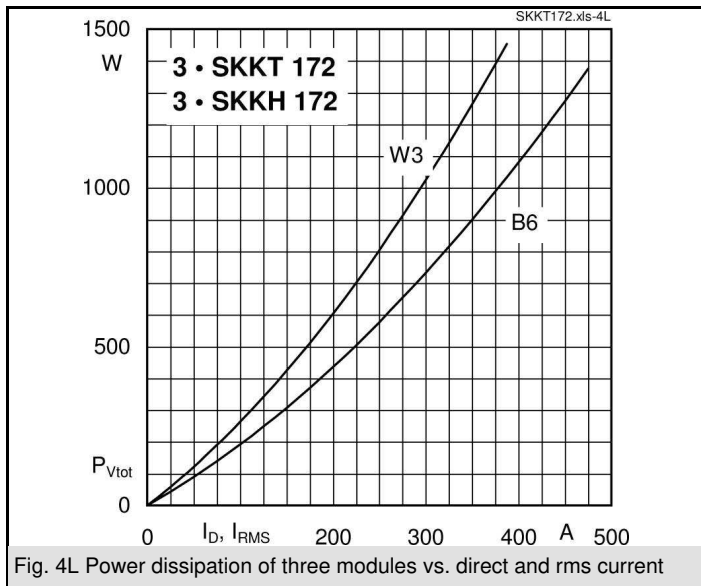

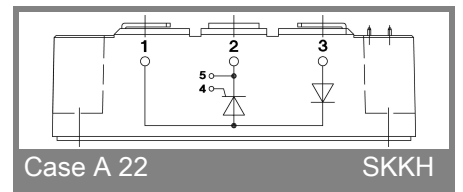
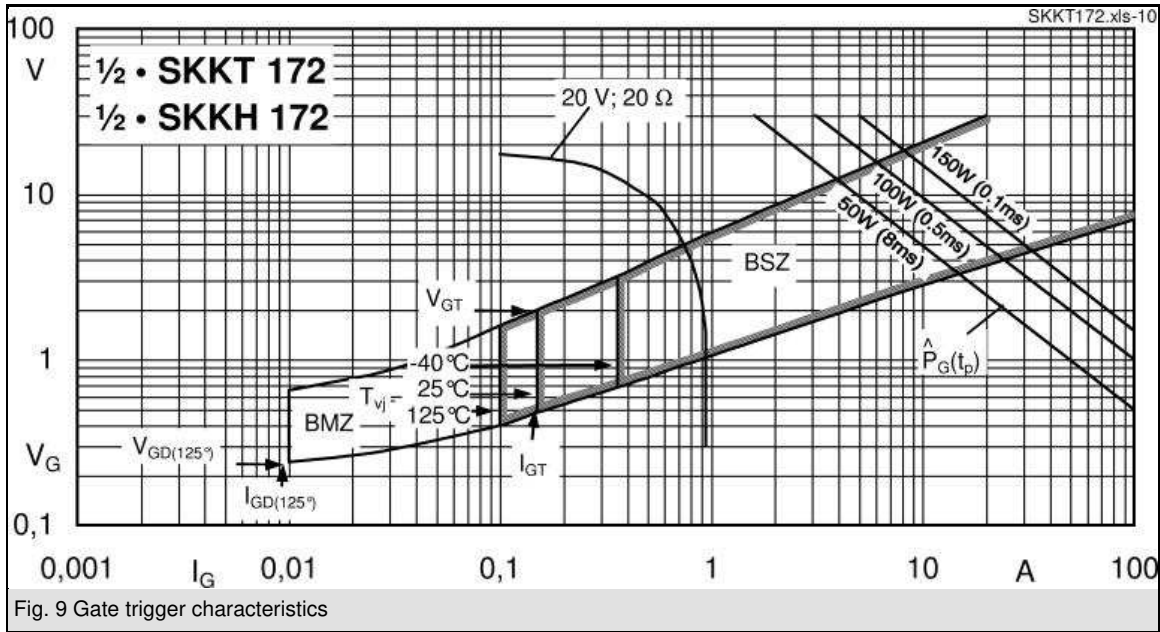

\* The specifications of our components may not be considered as an assurance of component characteristics. Components have to be tested for the respective application. Adjustments may be necessary. The use of SEMIKRON

products in life support appliances and systems is subject to prior specification and written approval by SEMIKRON. We therefore strongly recommend prior consultation of our personal.