

SKM 100GB063D

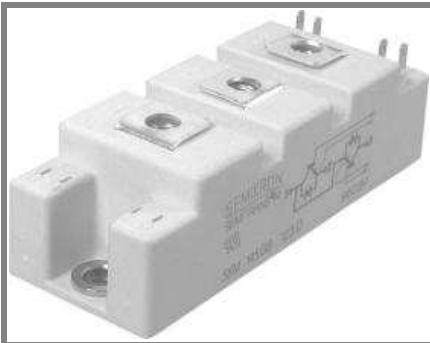

SEMITRANS® 2

Superfast NPT-IGBT Module

SKM 100GB063D

Features

- N channel, homogeneous Silicon structure (NPT- Non punch through IGBT)
- Low tail current with low temperature dependence
- High short circuit capability, self limiting if term. G is clamped to E
- Pos. temp.-coeff. of V_{CEsat}
- Very low C_{ies} , C_{oes} , C_{res}
- Latch-up free
- Fast & soft inverse CAL diodes
- Isolated copper Bonding Technology without hard mould
- Large clearance (10 mm) and creepage distances (20 mm)

Typical Applications*

- Switching (not for linear use)
- Switched mode power supplies
- UPS
- Three phase inverters for servo / AC motor speed control
- Pulse frequencies also above 10 kHz

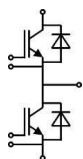

GB

Absolute Maximum Ratings		$T_c = 25^\circ\text{C}$, unless otherwise specified		
Symbol	Conditions	Values	Units	
IGBT				
V_{CES}	$T_j = 25^\circ\text{C}$	600	V	
I_C	$T_j = 150^\circ\text{C}$	$T_{case} = 25^\circ\text{C}$	130	A
		$T_{case} = 70^\circ\text{C}$	100	A
I_{CRM}	$I_{CRM} = 2 \times I_{Cnom}$	200	A	
V_{GES}		± 20	V	
t_{psc}	$V_{CC} = 300\text{V}; V_{GE} \leq 20\text{V}; T_j = 125^\circ\text{C}$ $V_{CES} < 600\text{V}$	10	μs	
Inverse Diode				
I_F	$T_j = 150^\circ\text{C}$	$T_{case} = 25^\circ\text{C}$	100	A
		$T_{case} = 80^\circ\text{C}$	75	A
I_{FRM}	$I_{FRM} = 2 \times I_{Fnom}$	200	A	
I_{FSM}	$t_p = 10\text{ms}; \text{sin.}$	$T_j = 150^\circ\text{C}$	720	A
Module				
$I_{t(RMS)}$		200	A	
T_{vj}		- 40 ... + 150	$^\circ\text{C}$	
T_{stg}		- 40 ... + 125	$^\circ\text{C}$	
V_{isol}	AC, 1 min.	2500	V	

Characteristics		$T_c = 25^\circ\text{C}$, unless otherwise specified			
Symbol	Conditions	min.	typ.	max.	Units
IGBT					
$V_{GE(th)}$	$V_{GE} = V_{CE}, I_C = 2\text{mA}$	4,5	5,5	6,5	V
I_{CES}	$V_{GE} = 0\text{V}, V_{CE} = V_{CES}$		0,1	0,3	mA
V_{CE0}		$T_j = 25^\circ\text{C}$	1,05		V
		$T_j = 125^\circ\text{C}$	1		V
r_{CE}	$V_{GE} = 15\text{V}$	$T_j = 25^\circ\text{C}$	10,5		m Ω
		$T_j = 125^\circ\text{C}$	14		m Ω
$V_{CE(sat)}$	$I_{Cnom} = 100\text{A}, V_{GE} = 15\text{V}$	$T_j = 25^\circ\text{C}_{chiplev.}$	2,1	2,5	V
		$T_j = 125^\circ\text{C}_{chiplev.}$	2,4	2,8	V
C_{res}	$V_{CE} = 25, V_{GE} = 0\text{V}$	$f = 1\text{MHz}$	5,6		nF
C_{oes}			0,6		nF
C_{res}			0,4		nF
Q_G	$V_{GE} = 0\text{V} - +15\text{V}$		240		nC
R_{Gint}	$T_j = ^\circ\text{C}$		0		Ω
$t_{d(on)}$	$R_{Gon} = 10\Omega$	$V_{CC} = 300\text{V}$ $I_C = 100\text{A}$	50		ns
t_r			40		ns
E_{on}			4		mJ
$t_{d(off)}$	$R_{Goff} = 10\Omega$	$T_j = 125^\circ\text{C}$ $V_{GE} = \pm 15\text{V}$	300		ns
t_f			35		ns
E_{off}			3		mJ
$R_{th(j-c)}$	per IGBT			0,27	K/W

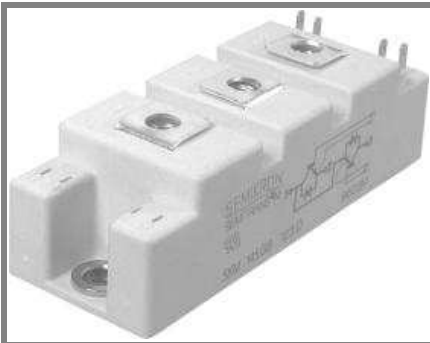

SEMITRANS® 2

Superfast NPT-IGBT Module

SKM 100GB063D

Features

- N channel, homogeneous Silicon structure (NPT- Non punch through IGBT)
- Low tail current with low temperature dependence
- High short circuit capability, self limiting if term. G is clamped to E
- Pos. temp.-coeff. of V_{CEsat}
- Very low C_{ies} , C_{oes} , C_{res}
- Latch-up free
- Fast & soft inverse CAL diodes
- Isolated copper Bonding Technology without hard mould
- Large clearance (10 mm) and creepage distances (20 mm)

Typical Applications*

- Switching (not for linear use)
- Switched mode power supplies
- UPS
- Three phase inverters for servo / AC motor speed control
- Pulse frequencies also above 10 kHz

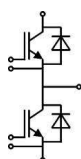

GB

Characteristics

Symbol	Conditions	min.	typ.	max.	Units
Inverse Diode					
$V_F = V_{EC}$	$I_{Fnom} = 100 \text{ A}; V_{GE} = 0 \text{ V}$		$T_j = 25 \text{ }^\circ\text{C}_{chiplev.}$ $T_j = 125 \text{ }^\circ\text{C}_{chiplev.}$	1,55 1,55	V V
V_{F0}			$T_j = 125 \text{ }^\circ\text{C}$	0,9	V
r_F			$T_j = 125 \text{ }^\circ\text{C}$	8 10	mΩ
I_{RRM}	$I_F = 100 \text{ A}$		$T_j = 125 \text{ }^\circ\text{C}$	44	A
Q_{rr}				6	μC
E_{rr}	$V_{GE} = -15 \text{ V}; V_{CC} = 300 \text{ V}$				mJ
$R_{th(j-c)D}$	per diode			0,6	K/W
Module					
L_{CE}				30	nH
R_{CC+EE}	res., terminal-chip	$T_{case} = 25 \text{ }^\circ\text{C}$ $T_{case} = 125 \text{ }^\circ\text{C}$		0,75 1	mΩ mΩ
$R_{th(c-s)}$	per module			0,05	K/W
M_s	to heat sink M6			3 5	Nm
M_t	to terminals M5			2,5 5	Nm
w				160	g

This is an electrostatic discharge sensitive device (ESDS), international standard IEC 60747-1, Chapter IX.

* The specifications of our components may not be considered as an assurance of component characteristics. Components have to be tested for the respective application. Adjustments may be necessary. The use of SEMIKRON products in life support appliances and systems is subject to prior specification and written approval by SEMIKRON. We therefore strongly recommend prior consultation of our personal.

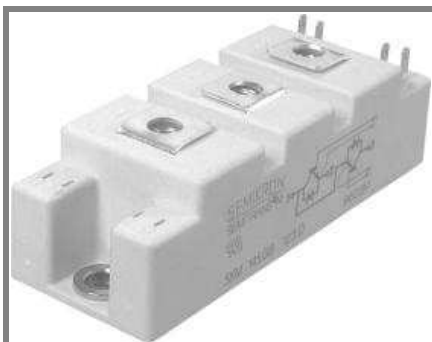

SEMITRANS[®] 2

Superfast NPT-IGBT Module

SKM 100GB063D

Features

- N channel, homogeneous Silicon structure (NPT- Non punch through IGBT)
- Low tail current with low temperature dependence
- High short circuit capability, self limiting if term. G is clamped to E
- Pos. temp.-coeff. of V_{CEsat}
- Very low C_{ies} , C_{oes} , C_{res}
- Latch-up free
- Fast & soft inverse CAL diodes
- Isolated copper Bonding Technology without hard mould
- Large clearance (10 mm) and creepage distances (20 mm)

Typical Applications*

- Switching (not for linear use)
- Switched mode power supplies
- UPS
- Three phase inverters for servo / AC motor speed control
- Pulse frequencies also above 10 kHz

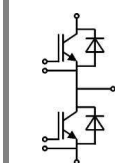

GB

Z_{th}			
Symbol	Conditions	Values	Units
$Z_{th(j-c)I}$			
$R_{\theta i}$	$i = 1$	160	mk/W
$R_{\theta i}$	$i = 2$	88	mk/W
$R_{\theta i}$	$i = 3$	18	mk/W
$R_{\theta i}$	$i = 4$	4	mk/W
$\tau_{\theta i}$	$i = 1$	0,0447	s
$\tau_{\theta i}$	$i = 2$	0,0087	s
$\tau_{\theta i}$	$i = 3$	0,0015	s
$\tau_{\theta i}$	$i = 4$	0,0002	s
$Z_{th(j-c)D}$			
$R_{\theta i}$	$i = 1$	400	mk/W
$R_{\theta i}$	$i = 2$	165	mk/W
$R_{\theta i}$	$i = 3$	30,5	mk/W
$R_{\theta i}$	$i = 4$	4,5	mk/W
$\tau_{\theta i}$	$i = 1$	0,0613	s
$\tau_{\theta i}$	$i = 2$	0,0085	s
$\tau_{\theta i}$	$i = 3$	0,0045	s
$\tau_{\theta i}$	$i = 4$	0,0003	s

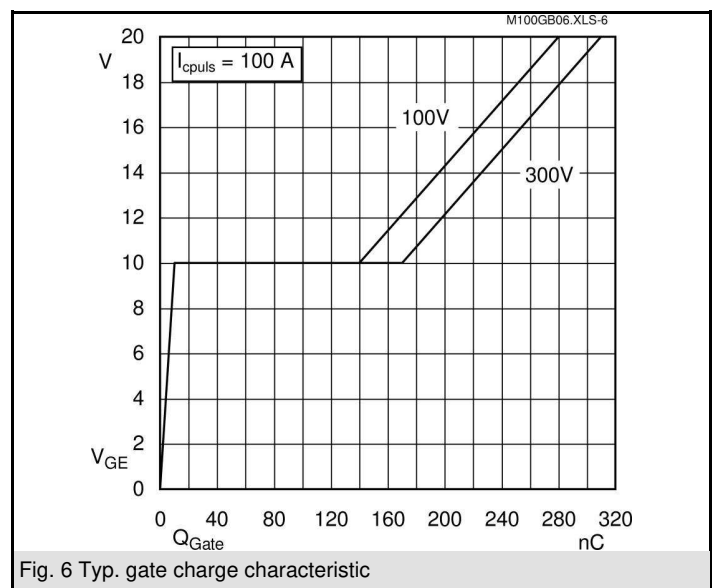
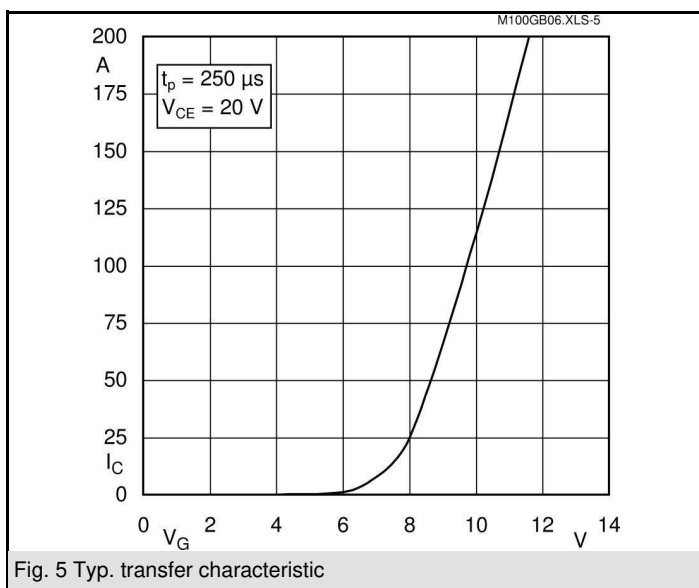
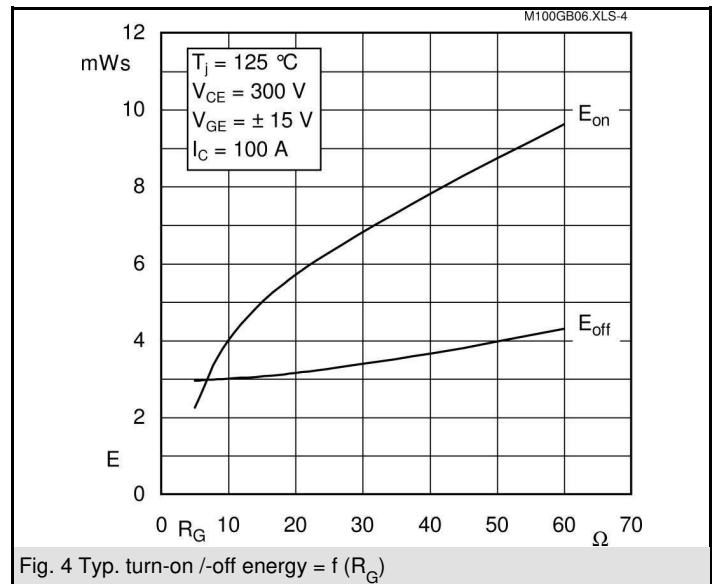
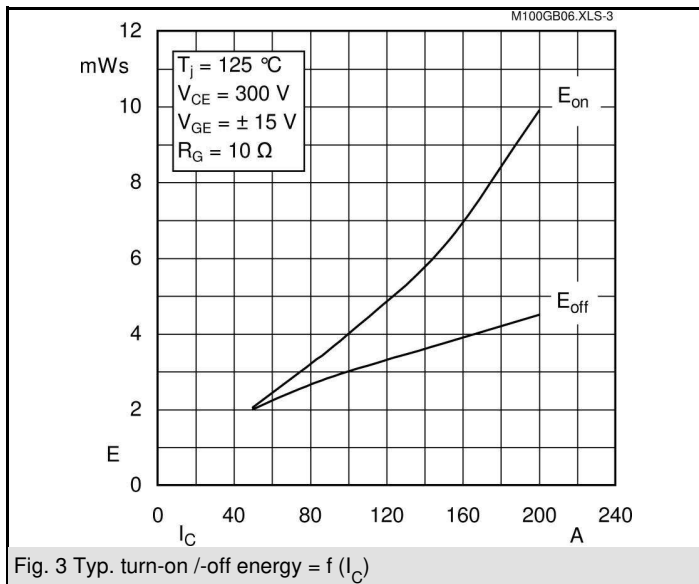
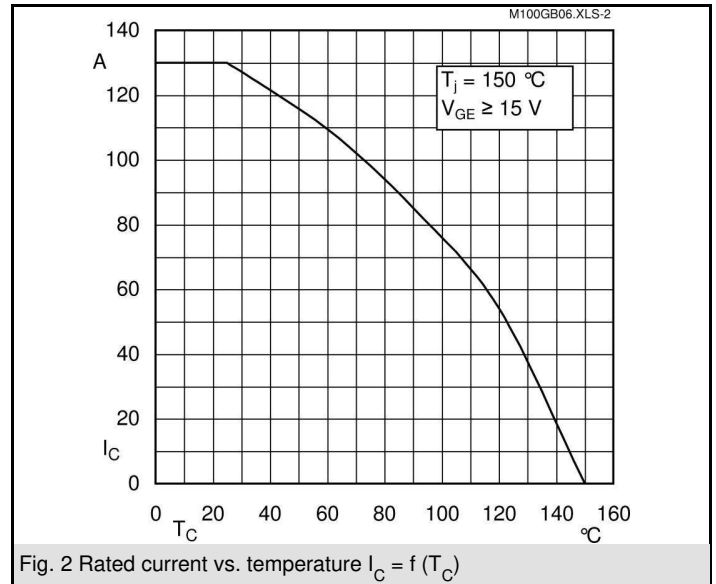
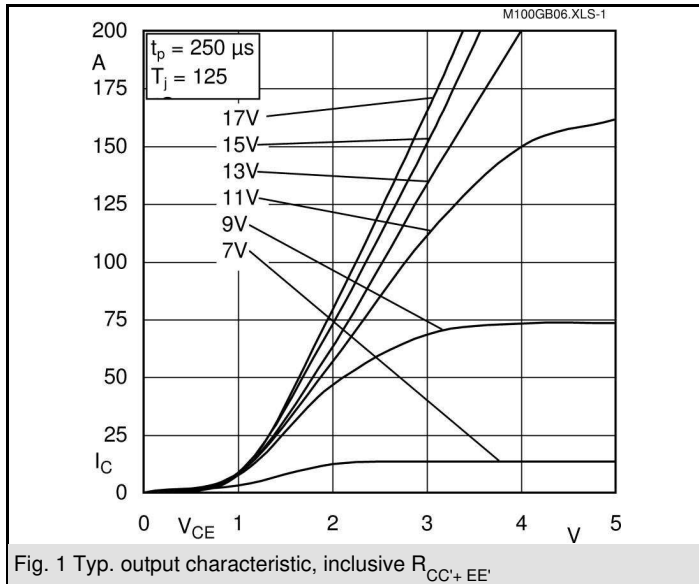

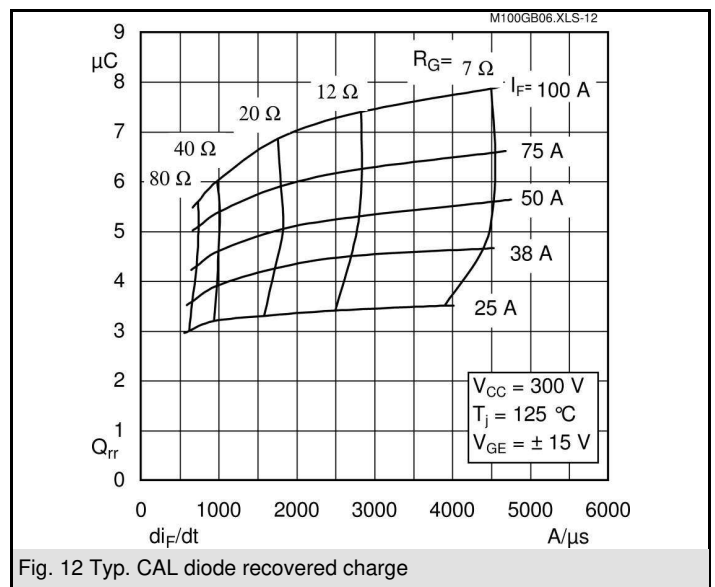
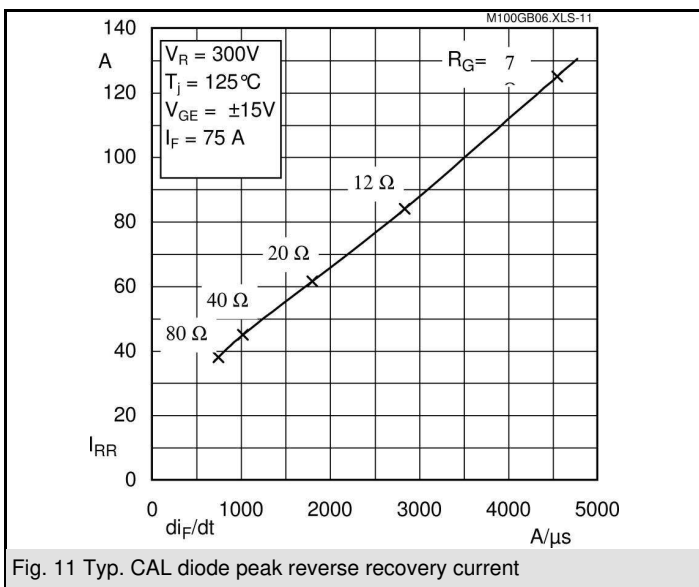
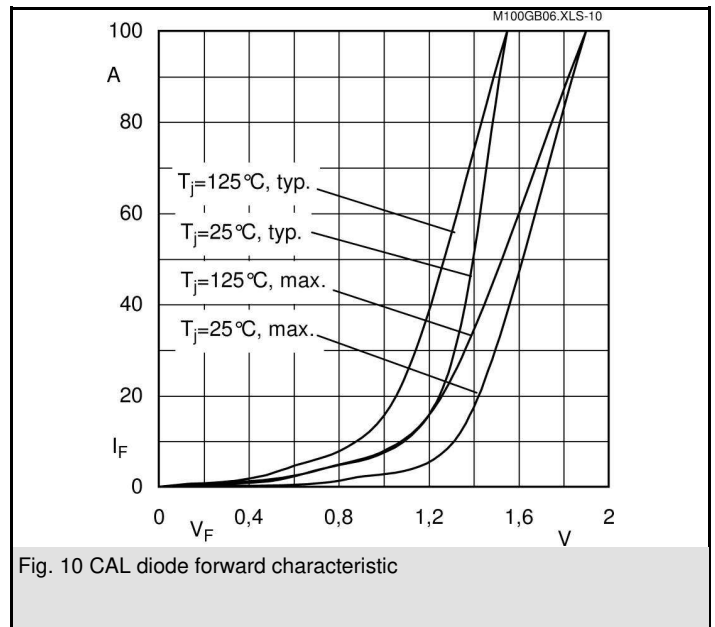
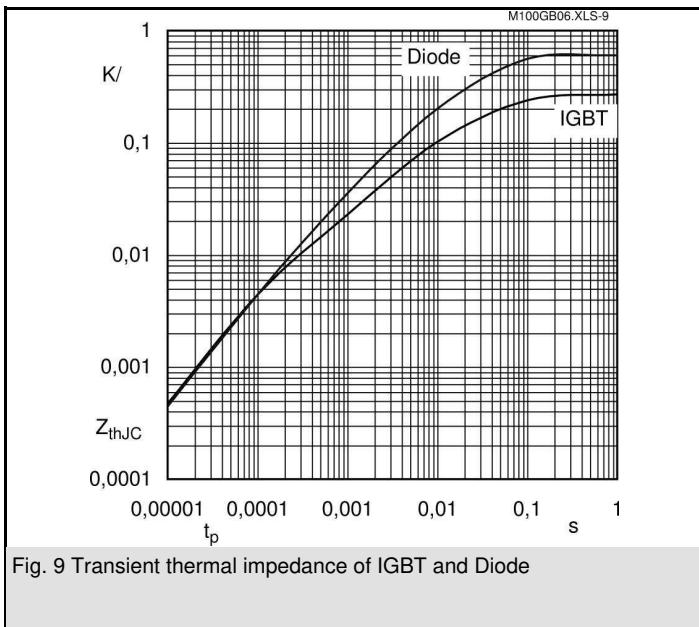
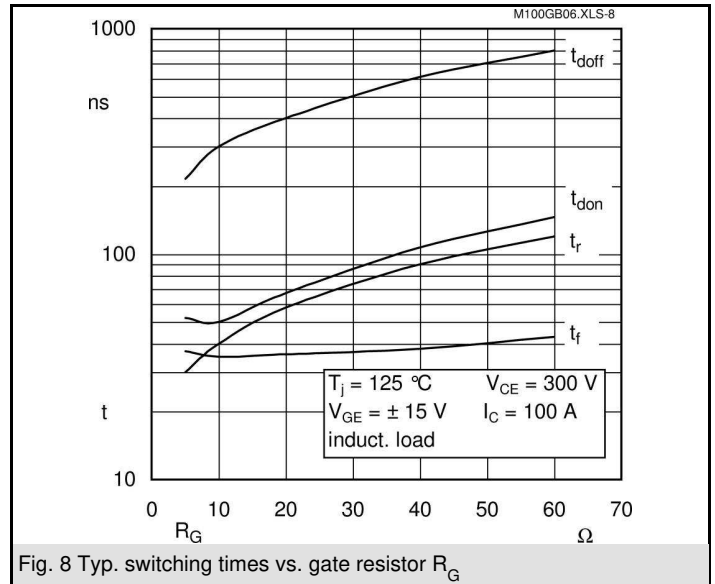
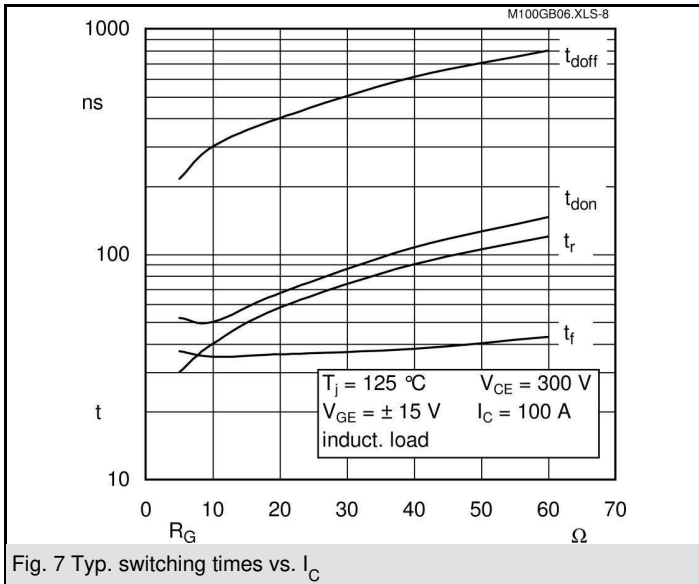

SKM 100GB063D

UL recognized file

CASED61

no. E 63 532

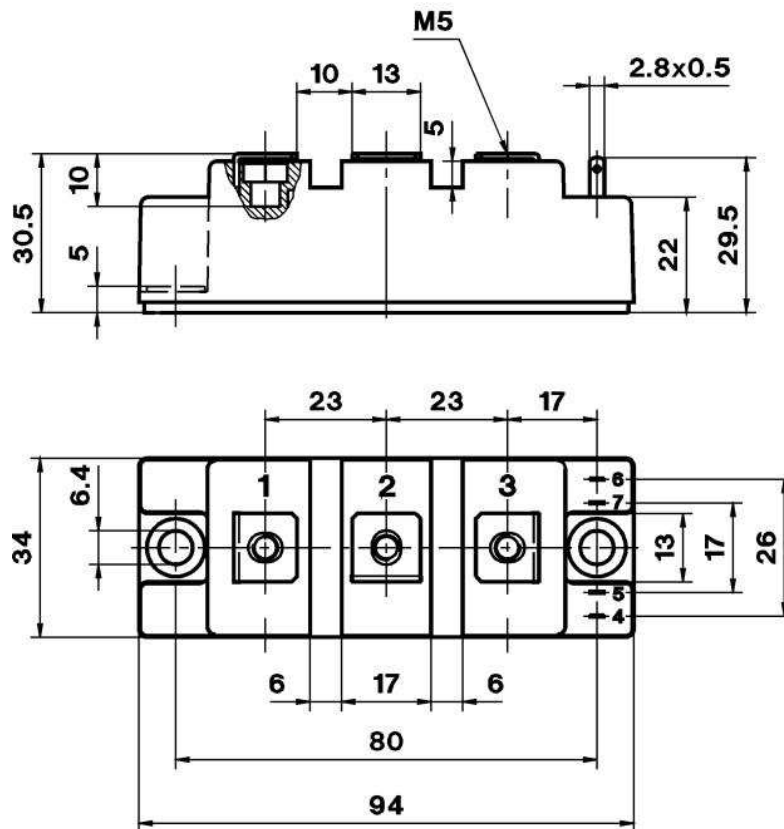

Case D 61

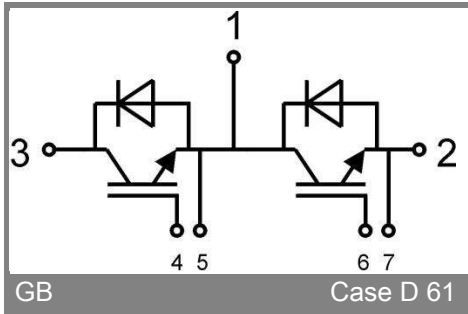

GB

Case D 61