

# THYRISTOR MODULE

# SCA (SCE) 130AA

UL: E76102 (M)

## SCA (SCE) 130AA

### 《Advantages》

- Isolated package
- di/dt 200A/ $\mu$ s
- dv/dt 1000V/ $\mu$ s
- IT(AV) 130A, IT(RMS) 205A, ITSM 5000A

### 《Applications》

- Various rectifiers, motor drives, Heater controls, and power supplies

### 《特長》

- 絶縁型パッケージ
- di/dt 200A/ $\mu$ s
- dv/dt 1000V/ $\mu$ s
- IT(AV) 130A, IT(RMS) 205A, ITSM 5000A

### 《用途》

- 整流器、モーター制御、ヒーター制御、各種電源装置

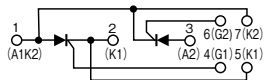

SCA

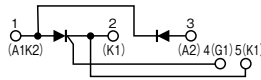

SCE

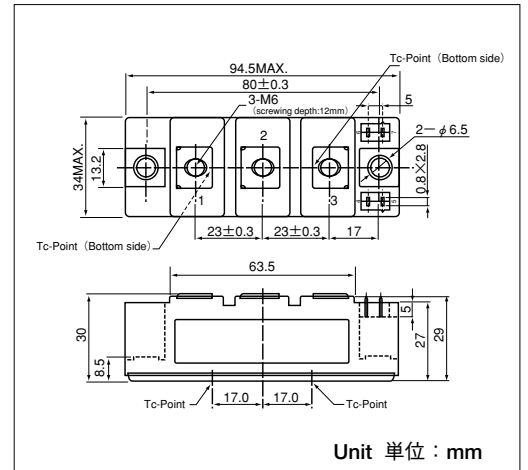

Unit 単位 : mm

## ■Maximum Ratings 最大定格

(Unless otherwise specified Tj=25°C / 指定なき場合はTj=25°Cとする)

Symbol 記号	Item 項目	Ratings 定格値			Unit 単位
		SCA130AA80 SCE130AA80	SCA130AA160 SCE130AA160	SCA130AA180 SCE130AA180	
V <sub>RRM</sub>	*Repetitive Peak Reverse Voltage * 定格ピーク繰返し逆電圧	800	1600	1800	V
V <sub>RSM</sub>	*Non-Repetitive Peak Reverse Voltage * 定格ピーク非繰返し逆電圧	960	1700	1900	V
V <sub>DRM</sub>	Repetitive Peak Off-state Voltage 定格ピーク繰返しオフ電圧	800	1600	1800	V

Symbol 記号	Item 項目	Conditions 条件	Ratings 定格値	Unit 単位
I <sub>T(AV)</sub> I <sub>F(AV)</sub>	*Average On-state (Forward) Current * 定格平均オン (順) 電流	Single phase, half wave, 180° conduction, T <sub>c</sub> =92°C 単相半波平均値180° 導通角	130	A
I <sub>T(RMS)</sub> I <sub>F(RMS)</sub>	*R.M.S. On-state (Forward) Current * 定格実効オン (順) 電流	Single phase, half wave, 180° conduction, T <sub>c</sub> =92°C 単相半波実効値180° 導通角	205	A
I <sub>TSM</sub> I <sub>FSM</sub>	*Surge On-state (Forward) Current * 定格サージオン (順) 電流	½cycle, 50/60Hz, Peak value, non-repetitive 50/60Hz 商用単相半波 1サイクル波高値 非繰返し	5000/5400	A
I <sup>2</sup> t	*I <sup>2</sup> t * 電流二乗時間積	Value for one cycle surge current 定格サージオン電流に対する値	125000	A <sup>2</sup> s
P <sub>GM</sub>	Peak Gate Power Dissipation 定格ピークゲート損失		10	W
P <sub>G(AV)</sub>	Average Gate Power Dissipation 定格平均ゲート損失		3	W
I <sub>FGM</sub>	Peak Gate Current 定格ピークゲート順電流		3	A
V <sub>FGM</sub>	Peak Gate Voltage (Forward) 定格ピークゲート順電圧		10	V
V <sub>RGM</sub>	Peak Gate Voltage (Reverse) 定格ピークゲート逆電圧		5	V
di/dt	Critical Rate of Rise of On-state Current 定格臨界オン電流上昇率	I <sub>G</sub> =100mA, V <sub>D</sub> =½V <sub>DRM</sub> , di <sub>G</sub> /dt=0.1A/ $\mu$ s	200	A/ $\mu$ s
V <sub>ISO</sub>	*Isolation Breakdown Voltage * 絶縁耐圧	A.C. 1minute 実効値, A.C. 1 分間	3000	V
T <sub>J</sub>	*Operating Junction Temperature * 定格接合部温度		-40~+125	°C
T <sub>stg</sub>	*Storage Temperature * 保存温度		-40~+125	°C
Mounting Torque 締付トルク	Mount (M6) 取付	Recommended value 推奨値	2.5~3.9N·m	N·m
	Terminal (M6) 主端子	Recommended value 推奨値	2.5~3.9N·m	
Mass 質量		Typical value 標準値	210	g

## ■Electrical Characteristics 電気的特性

(Unless otherwise specified Tj=25°C / 指定なき場合はTj=25°Cとする)

Symbol 記号	Item 項目	Conditions 条件	Ratings 定格値	Unit 単位
I <sub>DRM</sub>	Repetitive Peak Off-state Current, max 最大オフ電流	Tj=125°C, V <sub>D</sub> =V <sub>DRM</sub>	100	mA
I <sub>RRM</sub>	*Repetitive Peak Reverse Current, max *最大逆電流	Tj=125°C, V <sub>R</sub> =V <sub>RRM</sub>	100	mA
V <sub>TM</sub> V <sub>FM</sub>	*On-state (Forward) Voltage, max *最大オン(順)電圧	I <sub>T</sub> =500A	1.5	V
V <sub>T(TO)</sub>	*Threshold Voltage, max *最大閾値電圧	Tj=25°C	1.1	V
		Tj=125°C	0.94	
r <sub>t</sub>	*Dynamic Resistance, max *最大オン抵抗	Tj=25°C	0.84	mΩ
		Tj=125°C	1.22	
I <sub>GT</sub>	Gate Trigger Current, max 最大ゲートトリガ電流	V <sub>D</sub> =6V, I <sub>T</sub> =1A	100	mA
V <sub>GT</sub>	Gate Trigger Voltage, max 最大ゲートトリガ電圧	V <sub>D</sub> =6V, I <sub>T</sub> =1A	3	V
V <sub>GD</sub>	Gate Non-Trigger Voltage, min 最小ゲート非トリガ電圧	Tj=125°C, V <sub>D</sub> =½V <sub>DRM</sub>	0.25	V
dv/dt	Critical Rate of Rise of Off-state Voltage, min 最小臨界オフ電圧上昇率	Tj=125°C, V <sub>D</sub> =⅔V <sub>DRM</sub> , exp. waveform	1000	V/μs
R <sub>th(j-c)</sub>	*Thermal Impedance, max *最大熱抵抗	cont., Junction to case, per one element 接合部—ケース間 cont., 単位エレメント当り	0.18	°C/W
R <sub>th(j-c)</sub>	*Effective Thermal Impedance, max *最大実効熱抵抗	sin.180°, Junction to case, per one element 接合部—ケース間, sin.180°, 単位エレメント当り	0.19	°C/W
		rec.120°, Junction to case, per one element 接合部—ケース間, rec.120°, 単位エレメント当り	0.2	
R <sub>th(c-s)</sub>	*Interface Thermal Impedance, max *最大接触熱抵抗	Case to Heat sink, per one element ケース—ヒートシンク間, 単位エレメント当り Thermal conductivity (Silicon grease)=7×10 <sup>-3</sup> [W/cm·°C] シリコングリスの熱伝導率=7×10 <sup>-3</sup> [W/cm·°C]	0.1	°C/W

\*mark: Thyristor and Diode part, No mark: Thyristor part.

注) 上表中\*印の項目は、サイリスタ部及びダイオード部の両方に適用します。その他の項目は主にサイリスタ部に適用します。

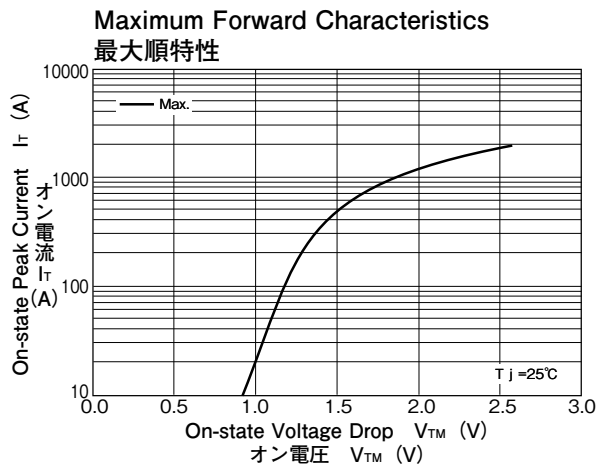
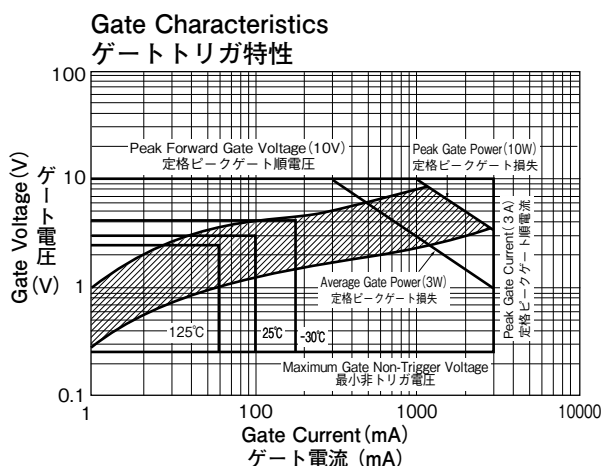

## Surge Forward Current Rating (Non-Repetitive)

サージ順電流耐量 (非繰返し)

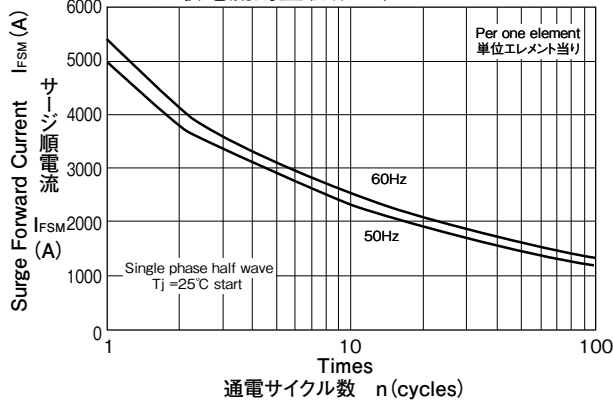

## Transient Thermal Impedance

過渡熱インピーダンス特性

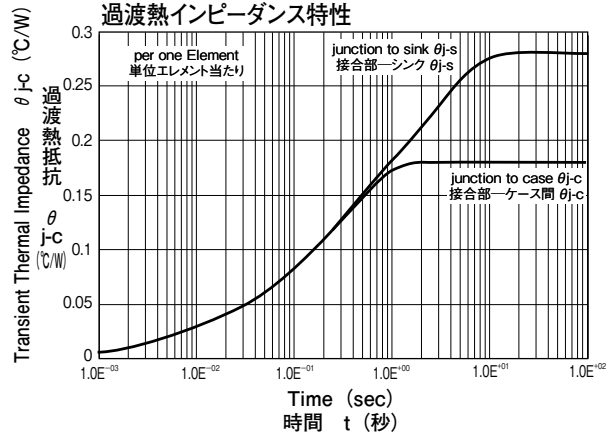

## Current vs Power Dissipation

最大電力損失特性

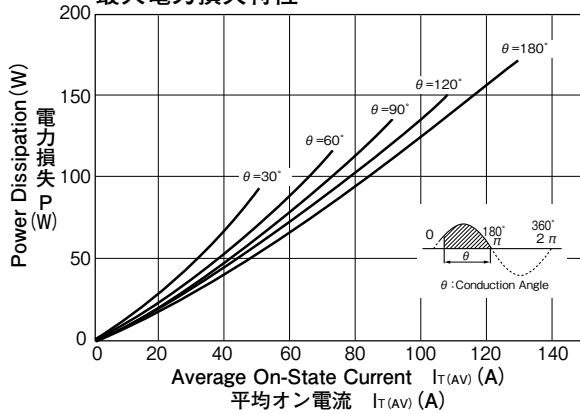

## Current vs Allowable Case Temperature

電流対最大許容ケース温度

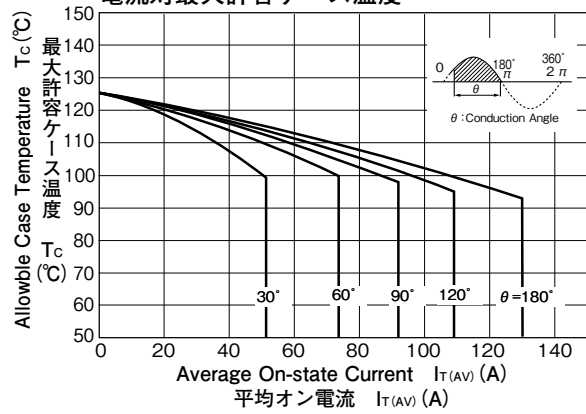

## Output Current (W1; Bidirectional connection)

許容出力電流 (W1; 逆並列接続)

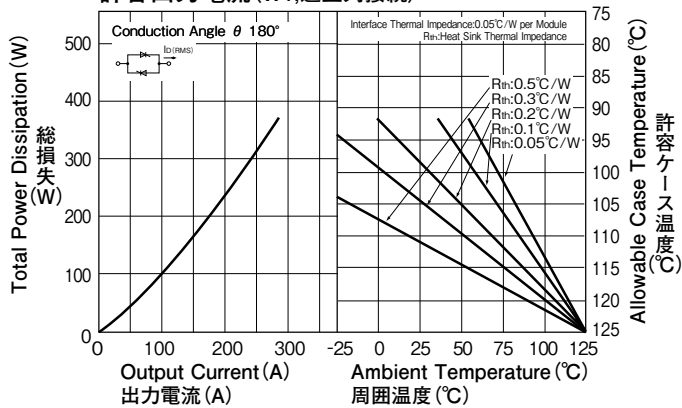

## Output Current (B2; Two pulse bridge connection)

許容出力電流 (B2; 单相ブリッジ接続)

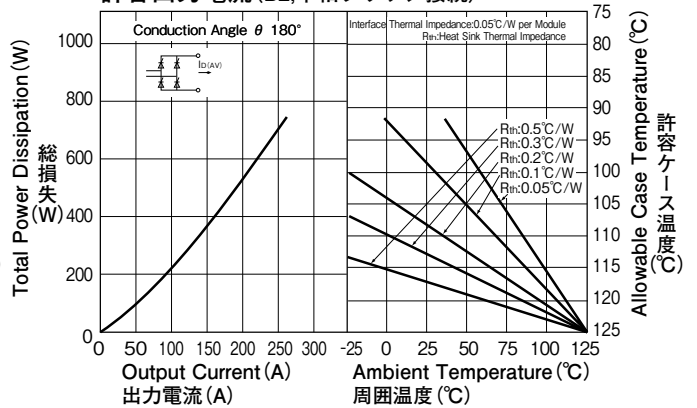

## Output Current

(B6; Six pulse bridge connection, W3; Three phase bidirectional connection)

許容出力電流 (B6; 三相ブリッジ接続, W3; 三相逆並列接続)

