

THYRISTOR MODULE (NON-ISOLATED TYPE)

PWB130A

PWB130A is a Thyristor module suitable for low voltage, 3 phase recifier applications.

- $I_{T(AV)}$ 130A (each device)
- high Surge Current 3500 A (50/60Hz)
- Easy Construction
- Non-isolated. Mounting base as common Anode terminal

(Applications)

Welding power Supply
Various DC power Supply

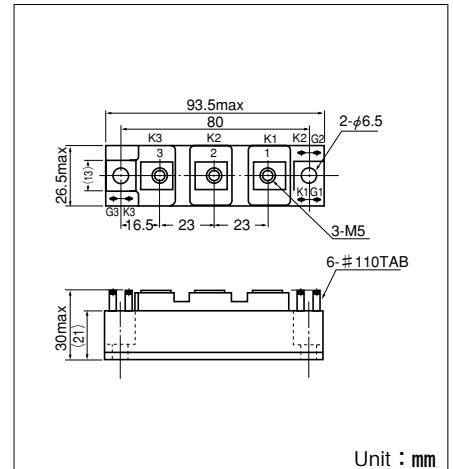
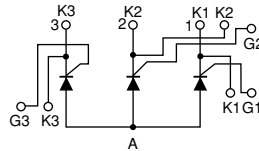

Maximum Ratings

Symbol	Item	Ratings			Unit
		PWB130A20	PWB130A30	PWB130A40	
VRRM	Repetitive Peak Reverse Voltage	200	300	400	V
VRSM	Non-Repetitive Peak Reverse Voltage	240	360	480	V
VDRM	Repetitive Peak Off-State Voltage	200	300	400	V

Symbol	Item	Conditions	Ratings	Unit	
$I_{T(AV)}$	Average On-State Current	Single phase, half wave, 180° conduction, $T_c : 112^\circ\text{C}$	130	A	
$I_{T(RMS)}$	R.M.S. On-State Current	Single phase, half wave, 180° conduction, $T_c : 112^\circ\text{C}$	204	A	
I_{TSM}	Surge On-State Current	1/2cycle, 50Hz/60Hz, peak value, non-repetitive	3200/3500	A	
I^2t	I^2t		51000	A ² S	
P_{GM}	Peak Gate Power Dissipation		10	W	
$P_{G(AV)}$	Average Gate Power Dissipation		1	W	
I_{FGM}	Peak Gate Current		3	A	
V_{FGM}	Peak Gate Voltage (Forward)		10	V	
V_{RGM}	Peak Gate Voltage (Reverse)		5	V	
di/dt	Critical Rate of On-State Current	$I_G=200\text{mA}$, $T_j=25^\circ\text{C}$, $V_D=1/2V_{DRM}$, $dI_G/dt=1\text{A}/\mu\text{s}$	50	A/ μs	
T_j	Operating Junction Temperature		-30 to +150	°C	
T_{stg}	Storage Temperature		-30 to +125	°C	
	Mounting torque	Mounting (M6)	Recommended 2.5-3.9 (25-40)	4.7 (48)	N·m (kgf·cm)
		Terminal (M5)	Recommended 1.5-2.5 (15-25)	2.7 (28)	
	Mass			170	g

Electrical Characteristics

Symbol	Item	Conditions	Ratings			Unit
			Mix.	Typ.	Min.	
I_{DRM}	Repetitive Peak Off-State Current, max.	at V_{DRM} , single phase, half wave, $T_j=150^\circ\text{C}$			30	mA
I_{RRM}	Repetitive Peak Reverse Current, max.	at V_{DRM} , single phase, half wave, $T_j=150^\circ\text{C}$			30	mA
V_{TM}	Peak On-State Voltage, max.	On-State Current 410A, $T_j=150^\circ\text{C}$ Inst. measurement			1.2	V
I_{GT}	Gate Trigger Current, max.	$T_j=25^\circ\text{C}$, $I_T=1\text{A}$, $V_D=6\text{V}$			150	mA/V
V_{GT}	Gate Trigger Voltage, max.	$T_j=25^\circ\text{C}$, $I_T=1\text{A}$, $V_D=6\text{V}$			2	mA/V
V_{GD}	Non-Trigger Gate, Voltage. min.	$T_j=150^\circ\text{C}$, $V_D=1/2V_{DRM}$	0.25			V
tgt	Turn On Time, max.	$I_T=100\text{A}$, $I_G=200\text{mA}$, $T_j=25^\circ\text{C}$, $V_D=1/2V_{DRM}$, $dI_G/dt=1\text{A}/\mu\text{s}$			10	μs
dv/dt	Critical Rate of Rise of Off-State Voltage, min.	$T_j=150^\circ\text{C}$, $V_D=2/3V_{DRM}$, Exponential wave.	50			V/ μs
I_H	Holding Current, typ.	$T_j=25^\circ\text{C}$			70	mA
$R_{th(j-c)}$	Thermal Impedance, max.	Junction to case (1/3 Module)			0.2	°C/W

Gate Characteristics

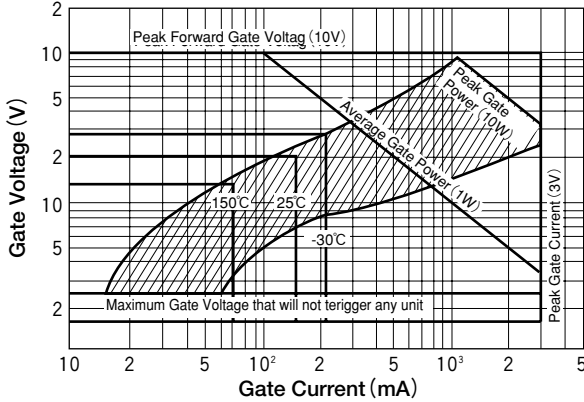

On-State Voltage max

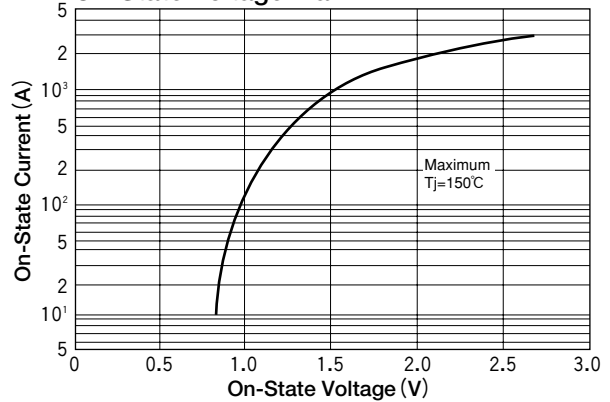

Average On-State Current Vs Power Dissipation (Single phase half wave)

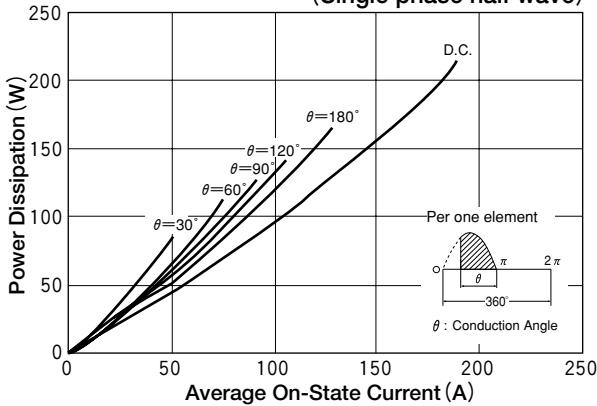

Average On-State Current Vs Maximum Allowable Case Temperature (Single phase half wave)

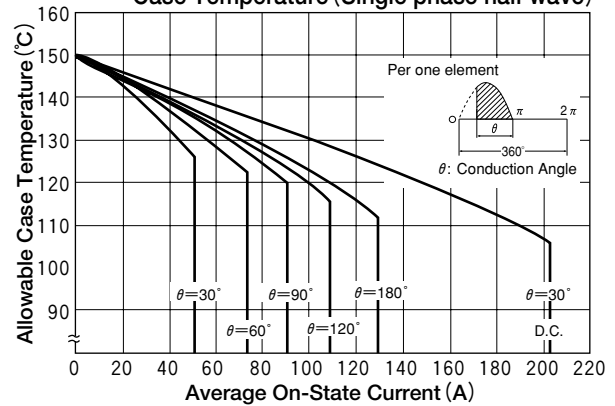

Surge On-State Current Rating (Non-Repetitive)

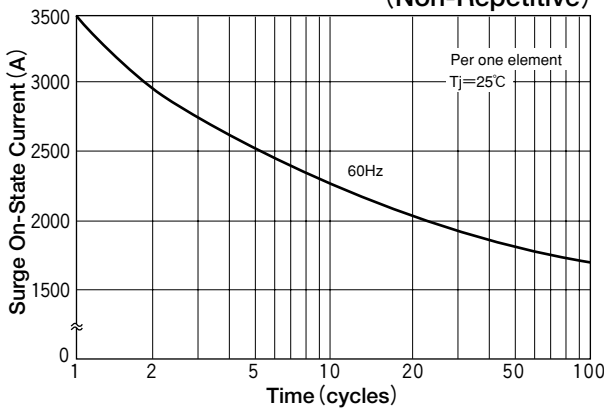

Transient Thermal Impedance

