

Standard Rectifier Module

$$V_{RRM} = 1600V$$

$$I_{FAV} = 608A$$

$$V_F = 1.01V$$

Single Diode

Part number

MDO600-16N1

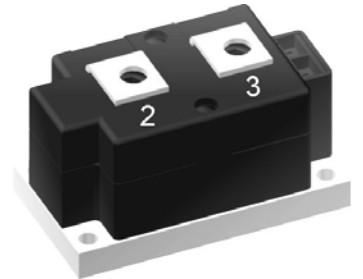

Backside: isolated

 E72873

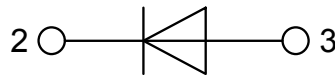

Features / Advantages:

- Planar passivated chips
- Very low leakage current
- Very low forward voltage drop
- Improved thermal behaviour

Applications:

- Diode for main rectification
- For single and three phase bridge configurations
- Supplies for DC power equipment
- Input rectifiers for PWM inverter
- Battery DC power supplies
- Field supply for DC motors

Package: Y1

- Isolation Voltage: 3600 V~
- Industry standard outline
- RoHS compliant
- Base plate: Copper internally DCB isolated
- Advanced power cycling

Rectifier				Ratings		
Symbol	Definition	Conditions	min.	typ.	max.	Unit
V_{RSM}	max. non-repetitive reverse blocking voltage	$T_{VJ} = 25^{\circ}C$			1700	V
V_{RRM}	max. repetitive reverse blocking voltage	$T_{VJ} = 25^{\circ}C$			1600	V
I_R	reverse current	$V_R = 1600 V$	$T_{VJ} = 25^{\circ}C$		1	mA
		$V_R = 1600 V$	$T_{VJ} = 140^{\circ}C$		30	mA
V_F	forward voltage drop	$I_F = 600 A$	$T_{VJ} = 25^{\circ}C$		1.12	V
					1.30	V
		$I_F = 1200 A$	$T_{VJ} = 125^{\circ}C$		1.01	V
					1.23	V
I_{FAV}	average forward current	$T_C = 85^{\circ}C$ 180° sine d = 0.5	$T_{VJ} = 140^{\circ}C$		608	A
V_{FO}	threshold voltage		$T_{VJ} = 140^{\circ}C$		0.76	V
r_F	slope resistance				0.32	mΩ
		} for power loss calculation only				
R_{thJC}	thermal resistance junction to case				0.072	K/W
R_{thCH}	thermal resistance case to heatsink			0.024		K/W
P_{tot}	total power dissipation		$T_C = 25^{\circ}C$		1600	W
I_{FSM}	max. forward surge current	t = 10 ms; (50 Hz), sine	$T_{VJ} = 45^{\circ}C$		15.0	kA
		t = 8,3 ms; (60 Hz), sine	$V_R = 0 V$		16.2	kA
		t = 10 ms; (50 Hz), sine	$T_{VJ} = 140^{\circ}C$		12.8	kA
		t = 8,3 ms; (60 Hz), sine	$V_R = 0 V$		13.8	kA
I^2t	value for fusing	t = 10 ms; (50 Hz), sine	$T_{VJ} = 45^{\circ}C$		1.13	MA ² s
		t = 8,3 ms; (60 Hz), sine	$V_R = 0 V$		1.09	MA ² s
		t = 10 ms; (50 Hz), sine	$T_{VJ} = 140^{\circ}C$		812.8	kA ² s
		t = 8,3 ms; (60 Hz), sine	$V_R = 0 V$		788.8	kA ² s
C_J	junction capacitance	$V_R = 400 V; f = 1 MHz$	$T_{VJ} = 25^{\circ}C$		762	pF

Package Y1				Ratings		
Symbol	Definition	Conditions	min.	typ.	max.	Unit
I_{RMS}	RMS current	per terminal			600	A
T_{VJ}	virtual junction temperature		-40		140	°C
T_{op}	operation temperature		-40		125	°C
T_{stg}	storage temperature		-40		125	°C
Weight				650		g
M_D	mounting torque		4.5		7	Nm
M_T	terminal torque		11		13	Nm
$d_{Sppl/App}$	creepage distance on surface striking distance through air	terminal to terminal	16.0			mm
$d_{Spb/Apb}$		terminal to backside	25.0			mm
V_{ISOL}	isolation voltage	t = 1 second	3600			V
		t = 1 minute	3000			V

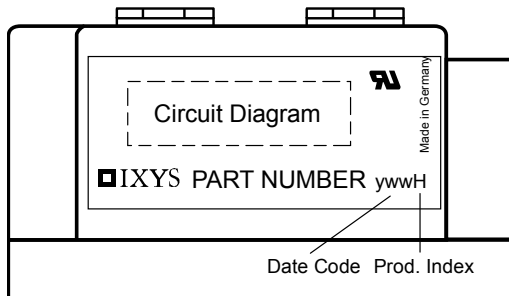

Ordering	Part Number	Marking on Product	Delivery Mode	Quantity	Code No.
Standard	MDO600-16N1	MDO600-16N1	Box	3	509707

Equivalent Circuits for Simulation

* on die level

$T_{VJ} = 140\text{ °C}$

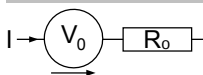

Rectifier

$V_{0\max}$	threshold voltage	0.76	V
$R_{0\max}$	slope resistance *	0.13	mΩ

Outlines Y1

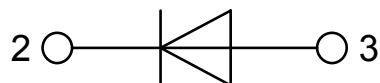
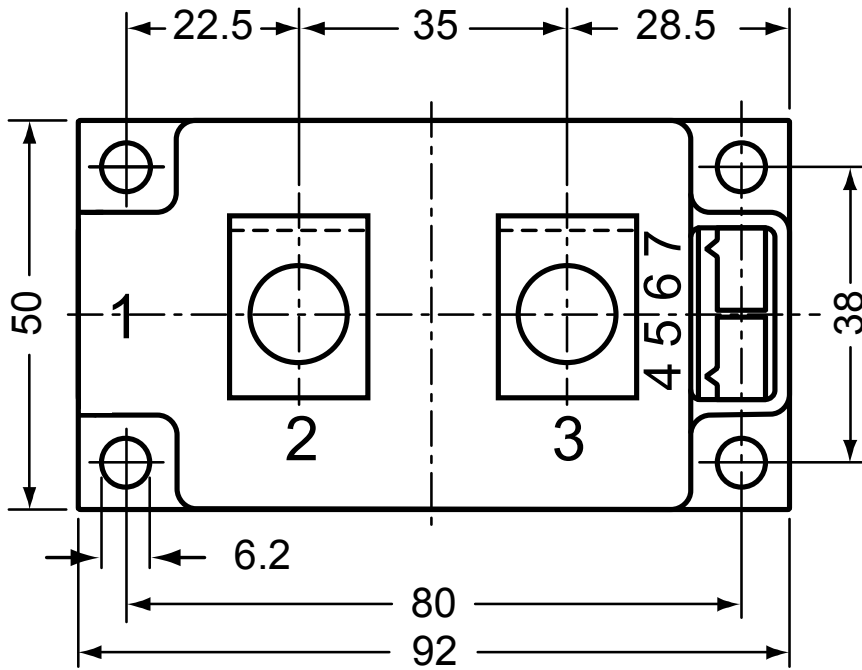
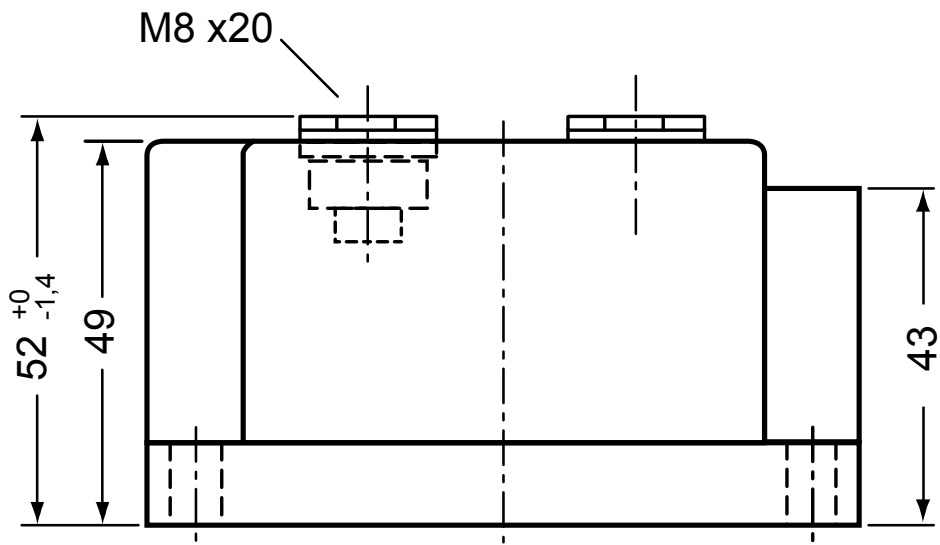

Rectifier

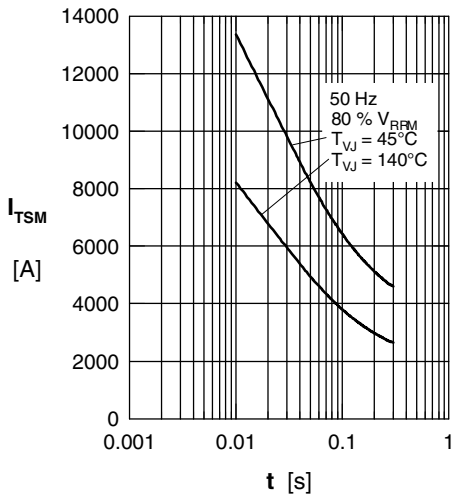

Fig. 1 Surge overload current
 I_{FSM} : Crest value, t : duration

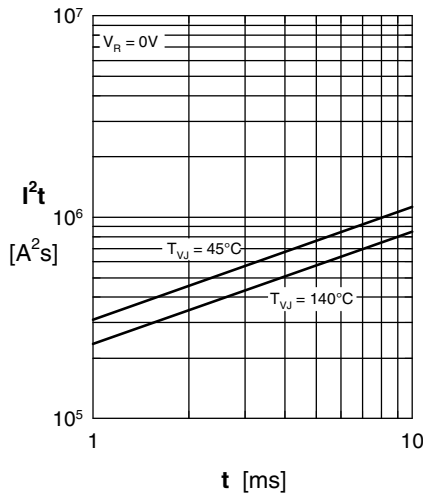

Fig. 2 I^2t versus time (1-10 ms)

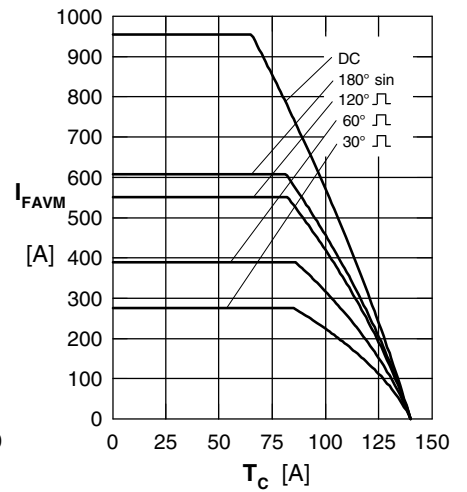

Fig. 3 Max. forward current at case temperature

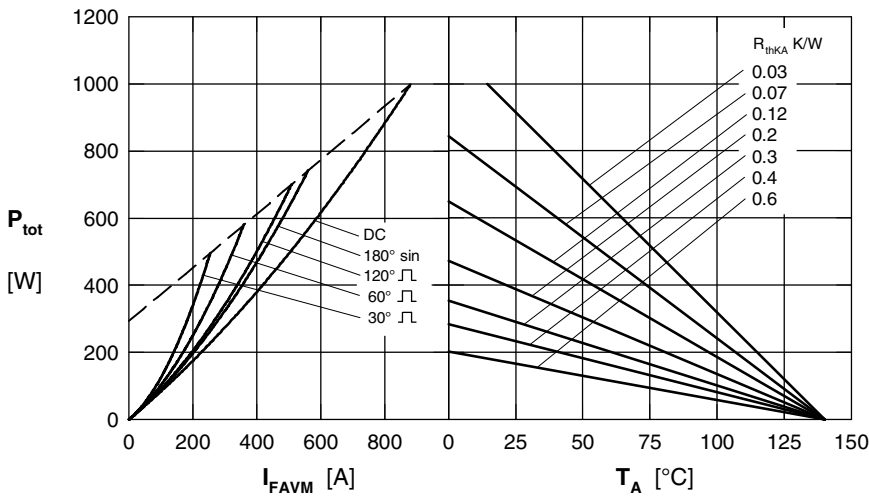

Fig. 4 Power dissipation vs. forward current and ambient temperature

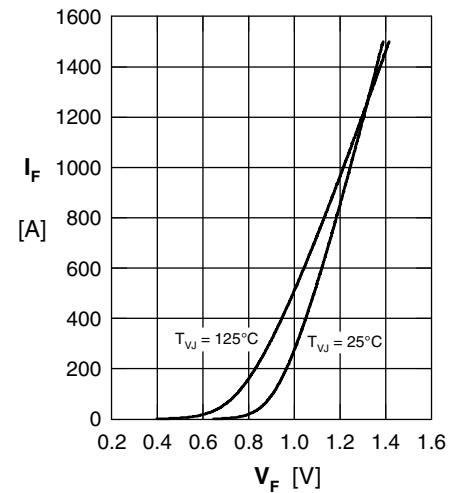

Fig. 5 Forward current I_F vs. V_F

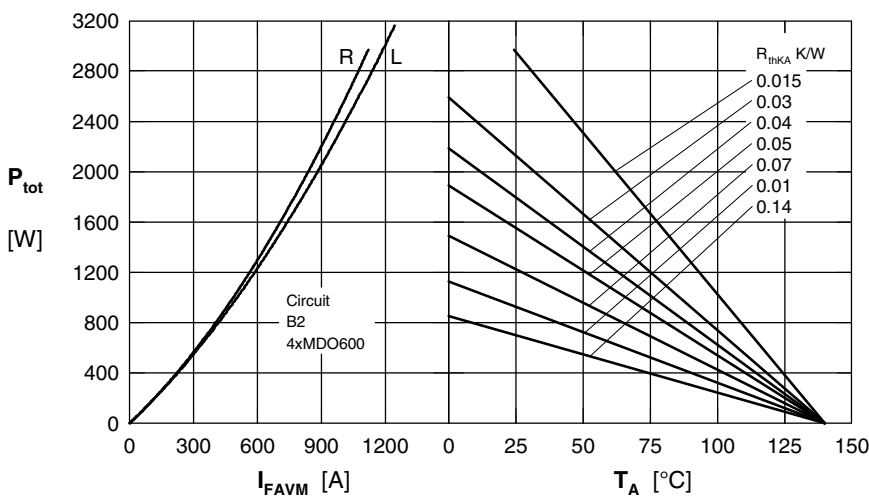

Fig. 6 Single phase rectifier bridge: Power dissipation vs. direct output current and ambient temperature R = resistive load, L = inductive load

Rectifier

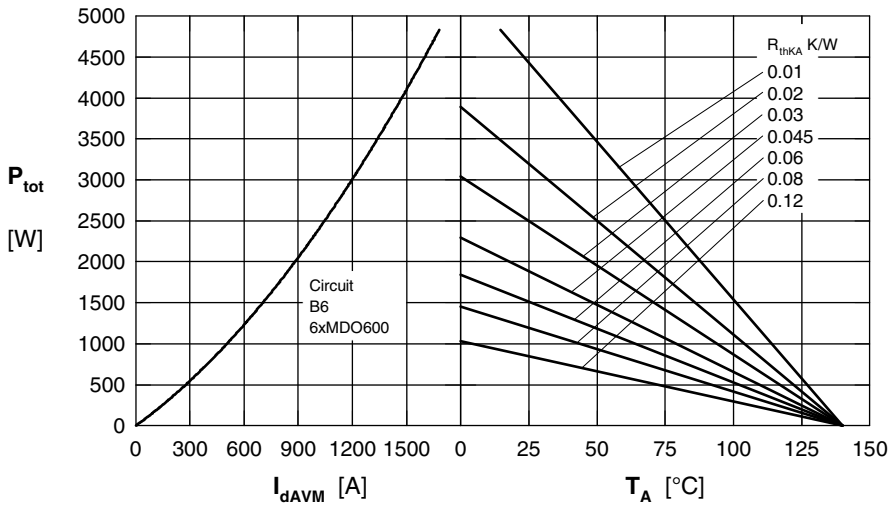

Fig. 7 Three phase rectifier bridge: Power dissipation versus direct output current and ambient temperature

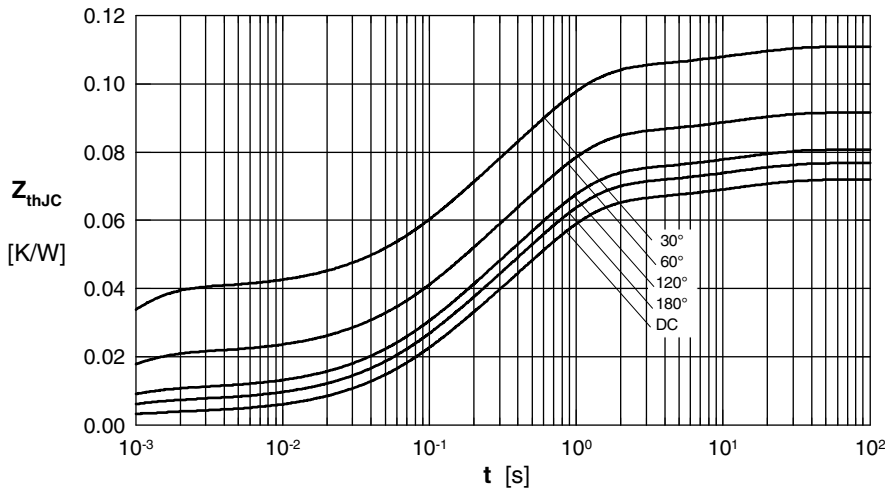

Fig. 8 Transient thermal impedance junction to case

R_{thJC} for various conduction angles d:

d	R_{thJC} (K/W)
DC	0.072
180°	0.0768
120°	0.081
60°	0.092
30°	0.111

Constants for Z_{thJC} calculation:

i	R_{thi} (K/W)	t_i (s)
1	0.0035	0.0054
2	0.0186	0.098
3	0.0432	0.54
4	0.0067	12

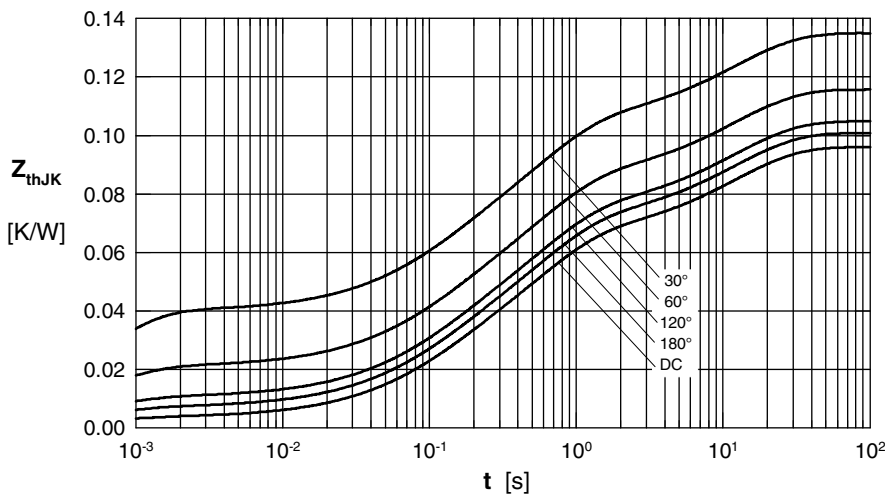

Fig. 9 Transient thermal impedance junction to heatsink

R_{thJK} for various conduction angles d:

d	R_{thJK} (K/W)
DC	0.096
180°C	0.1
120°C	0.105
60°C	0.116
30°C	0.135

Constants for Z_{thJK} calculation:

i	R_{thi} (K/W)	t_i (s)
1	0.0035	0.0054
2	0.0186	0.098
3	0.0432	0.54
4	0.067	12
5	0.024	12